

— THE —
ORGANIC
COMPANY

IT MATTERS

2021 | No.2



Nature's resources are not inexhaustible.
Therefore, we need to follow new, sustainable
paths by consuming less and generating
less waste.

CONTENT

REUSABLES

- 28 | Kitchen cloth
- 42 | Tea bag and set
- 46 | Food bag **NEW COLOR**
- 48 | Food bag set **NEW COLOR**
- 54 | Everyday napkin **NEW COLOR**
- 58 | Lunch bag
- 98 | Calm wash cloths
- 100 | Calm makeup pads
- 112 | Big waffle wash cloth **NEW COLOR**
- 114 | Big waffle makeup pads **NEW COLOR**
- 128 | Washing bag and set
- 136 | My organic bag **NEW COLOR**
- 138 | It matters bag **NEW PRODUCT**
- 140 | All purpose bag **NEW COLOR**
- 142 | All purpose bag set **NEW COLOR**
- 146 | Net bag
- 150 | Gift wrapping set

KITCHEN AND COOKING

- 20 | Kitchen towel **NEW COLOR**
- 24 | Gift set I
- 28 | Kitchen cloth
- 30 | Kitchen cloths 3-pack **NEW PRODUCT**
- 32 | Display kitchen cloths
- 34 | Gift set II
- 38 | Little towel
- 42 | Tea bag and set
- 46 | Food bag **NEW COLOR**
- 48 | Food bag set **NEW COLOR**
- 52 | Dinner napkin **NEW PRODUCT**
- 54 | Everyday napkin **NEW COLOR**
- 58 | Lunch bag
- 60 | Tea cosy **NEW COLOR**
- 62 | Coffee cosy
- 64 | Oven gloves
- 68 | Oven mitts **NEW COLOR**
- 70 | Creative and garden apron **NEW COLOR**
- 72 | Apron with pockets
- 76 | Giant kitchen towel **NEW COLOR**

BATH AND WELLNESS

- 84 | Fine bath towel **NEW PRODUCT**
- 86 | Fine hand towel **NEW PRODUCT**
- 90 | Calm towel to wrap
- 92 | Calm towel to go
- 96 | Calm hand towel
- 98 | Calm wash cloths
- 100 | Calm makeup pads
- 104 | Big waffle towel and blanket **NEW COLOR**
- 106 | Big waffle medium towel **NEW COLOR**
- 108 | Big waffle hand towel **NEW COLOR**
- 112 | Big waffle wash cloth **NEW COLOR**
- 114 | Big waffle makeup pads **NEW COLOR**
- 118 | Big waffle bath mat **NEW COLOR**
- 122 | Wellness towel
- 124 | Towel to wrap around you
- 126 | Hand hair towel
- 128 | Washing bag and set

BAGS AND STORAGE

- 132 | Big long bag
- 134 | Laundry and storage bag
- 136 | My organic bag **NEW COLOR**
- 138 | It matters bag **NEW PRODUCT**
- 140 | All purpose bag **NEW COLOR**
- 142 | All purpose bag set **NEW COLOR**
- 146 | Net bag
- 150 | Gift wrapping set

RELAX AND MEDITATION

- 154 | 6-layer soft blanket
- 156 | Meditation block
- 160 | Meditation cushion flat
- 162 | Meditation mattress - to go
- 164 | Meditation mattress



OUR PURPOSE

In a time when humanity needs to rethink the future to sustain life on this planet, we consider responsible business a necessary game changer.

We imagine a world in which all businesses, regardless of size, take social, environmental and financial responsibility in all parts of the supply chain.

It is not naive. It is the inevitable future.

That is why we offer products made of 100% GOTS certified organic cotton for customers who want luxurious, sustainable goods of premium quality.

We want our products to last long enough to be passed on. And we insist on developing a new, sustainable standard of designed goods.

So we take no shortcuts and we constantly challenge to improve. That is how we make a small difference every day.

One certified organic product at a time.

We believe in the human ability to create change. We believe that respect comes when respect is given and we believe in the future.

This is why we are here.

RESPONSIBLE BUSINESS

Joy Vasiljev is known as a visionary, inspiring and uncompromising entrepreneur, who is not afraid to speak up and point out things that are not right.

It all started with a lot of questions. Why is it so hard to find textiles that combine great design with organic materials? Why do we have to choose between the two? Are we showing responsible behavior when it comes to protecting our planet?

In 2007, The Organic Company was established with the clear mission of proving that a responsible business is good business.

Every product is thoroughly considered with regards to both design and purpose because Joy believes that the better the product, the better you take care of it.

And this fits well with an organic lifestyle.

It was not an easy start. The world simply wasn't ready. And people were unaware of the extremely dirty industry of cotton.

14 years later, The Organic Company produces more than 200 different products and exports to more than 26 countries.

Today, Joy is an important voice in the debate on organic lifestyle, environment and sustainability. She teaches and gives speeches in order to open people's eyes to the fact that there are different and better ways of doing things.

Good intentions aren't enough. Change demands action.



IT MATTERS



MORE THAN A PRODUCT

GOTS stands for Global Organic Textile Standard

GOTS is a social and environmental standard within cotton production

GOTS production takes care of workers, wild life and our vital eco system

GOTS covers the entire supply chain

GOTS is based on thorough and unannounced inspections. Every year

GOTS is a needed difference in a dirty industry

Our GOTS license DK21797

We are 100% GOTS certified and have been for 10 years

The Organic Company

License no 21797



COLOR CONCEPT

When Joy designed our checked kitchen towels she grouped all our colors and color themes appeared.

“And when displaying the colors groupwise, calmness and connection came” she adds.

The theme names are all rooted in the nature surrounding us: earth, ocean and floral.

The classic theme is inspired by Nordic noir and the many months of dark color surroundings in Scandinavia.

We hope to inspire you with these color combinations. They show you a possible way to display our colors in groups in a fine harmony, both in the stores and at home.

color: stone
no: 202



color: pale yellow
no: 210



NEW COLOR

color: sky
no: 570

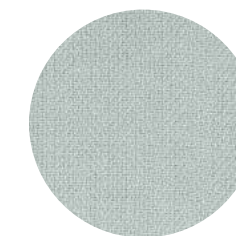

color: natural white
no: 200



color: dusty lavender
no: 340

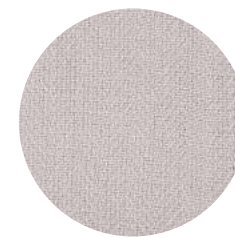

color: khaki
no: 215

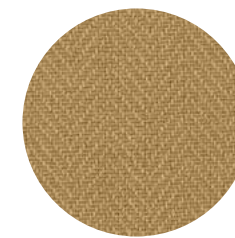

color: grey blue
no: 510

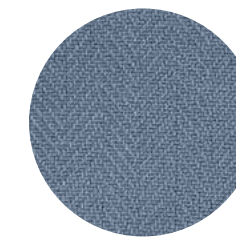

color: dusty mint
no: 410

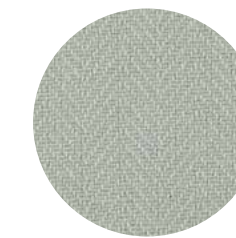

NEW COLOR

color: pale rose
no: 331

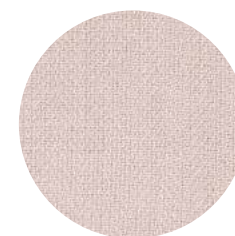

color: clay
no: 225

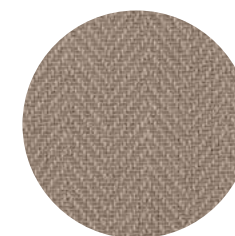

color: dark blue
no: 500

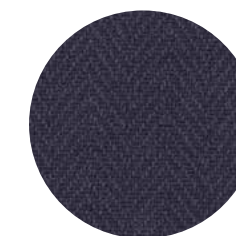

color: dark green
no: 400

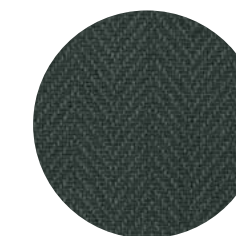

color: coral
no: 385

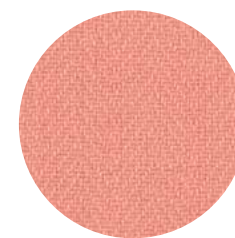

color: maroon
no: 390



NEW COLOR

color: dark grey
no: 110

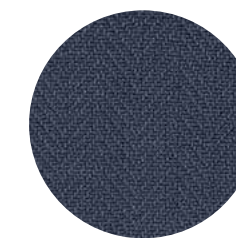

color: black
no: 100

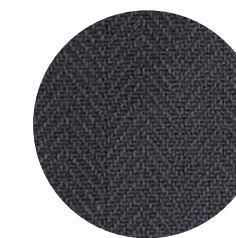



COLOR CONCEPT / OCEAN

color: sky
no: 570

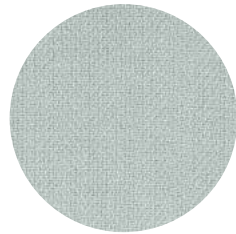

color: grey blue
no: 510

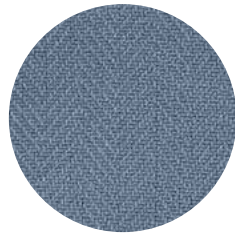

color: dark blue
no: 500

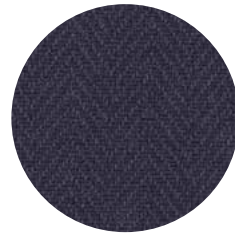

color: dusty mint
no: 410

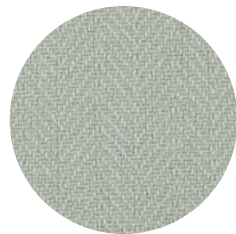

color: dark grey
no: 110

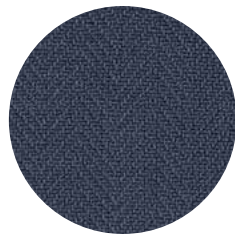

color: black
no: 100

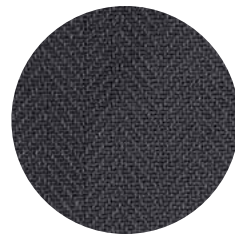

color: natural white
no: 200



COLOR CONCEPT / CLASSIC

color: stone
no: 202



color: dark grey
no: 110

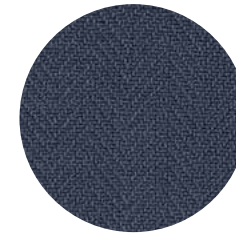

color: clay
no: 225

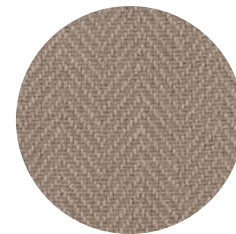

color: black
no: 100

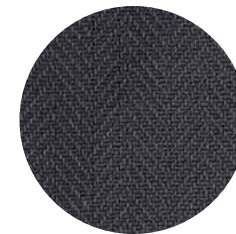

color: natural white
no: 200





COLOR CONCEPT / FLORAL

color: natural white
no: 200



color: pale rose
no: 331



color: coral
no: 385

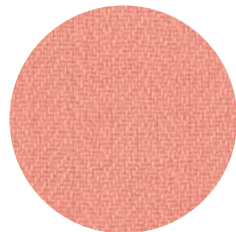

color: pale yellow
no: 210



color: stone
no: 202



color: dusty lavender
no: 340



color: khaki
no: 215

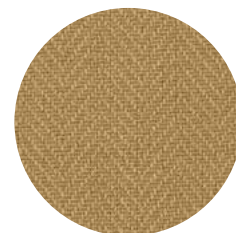

color: dusty mint
no: 410

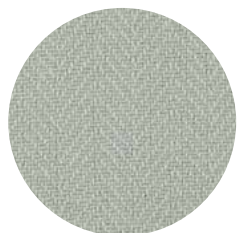

COLOR CONCEPT / EARTH

color: natural white
no: 200



color: clay
no: 225

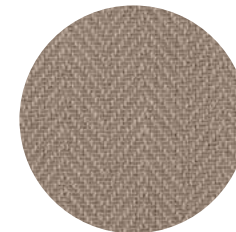

color: dark green
no: 400

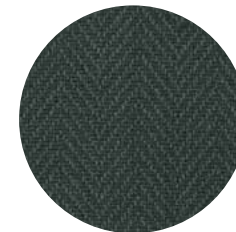

color: stone
no: 202

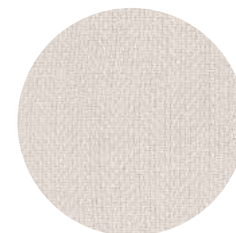

color: khaki
no: 215

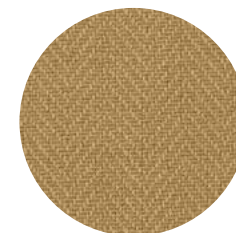

color: dark grey
no: 110

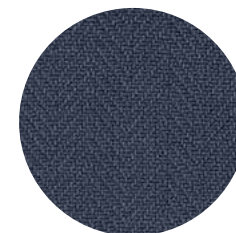

A photograph of two chefs in a kitchen. The chef on the left is wearing a dark blue long-sleeved shirt and a light grey apron, pouring contents from a brown paper bag into a terracotta bowl. The chef on the right is wearing a white long-sleeved shirt and a dark grey apron, with their hand on the bowl. The background is a blurred kitchen with wooden surfaces and various kitchen items.

KITCHEN AND COOKING

KITCHEN TOWEL

VISKESTYKKE | GESCHIRHANDTUCH | TORCHON

Style no: **TOC 1041**
 Size: **53 x 86 cm / 20.8 x 33.8"**
 Weaving: **Herringbone**
 Material: **100% GOTS certified organic cotton**
 MOQ: **8 pieces**

RRP
 DKK: **135,-**
 EUR: **19.90**
 NOK: **195,-**
 SEK: **195,-**
 USD-L: **24.00**
 CAD-L: **32.00**

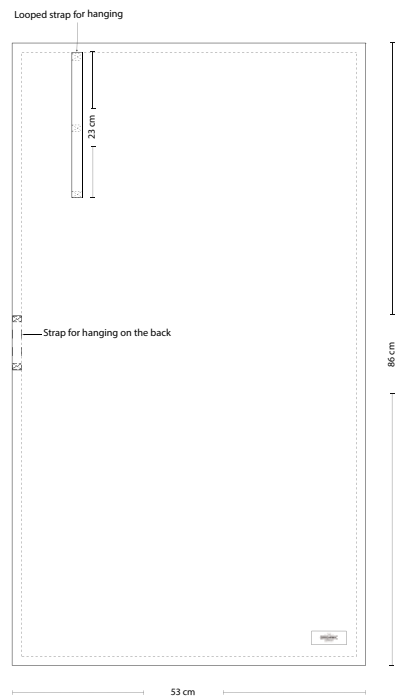

Our Kitchen towel is voted "best in test" due to its' unique ability to absorb, and because it keeps looking great in the kitchen, wash after wash.

color: stone
no: 202



color: pale yellow
no: 210



NEW COLOR

color: sky
no: 570

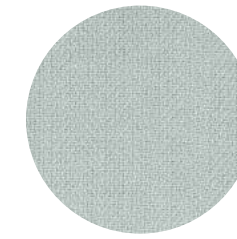

color: natural white
no: 200



color: dusty lavender
no: 340

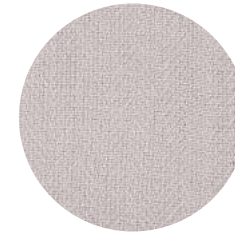

color: khaki
no: 215

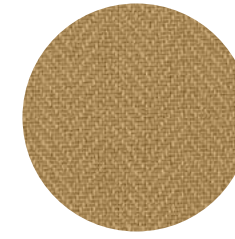

color: grey blue
no: 510

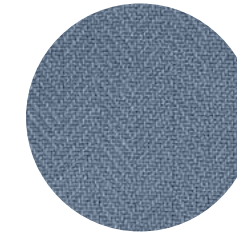

color: dusty mint
no: 410

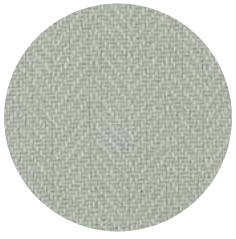

NEW COLOR

color: pale rose
no: 331

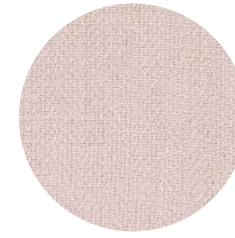

color: clay
no: 225

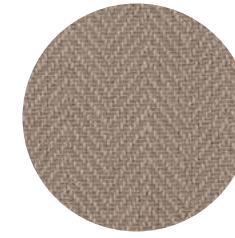

color: dark blue
no: 500

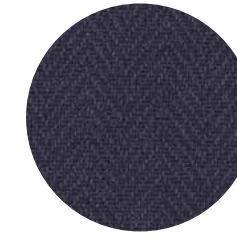

color: dark green
no: 400

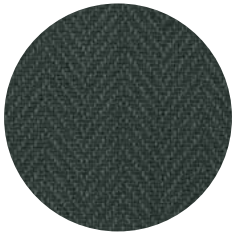

color: coral
no: 385

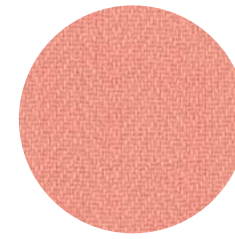

color: maroon
no: 390



NEW COLOR

color: dark grey
no: 110

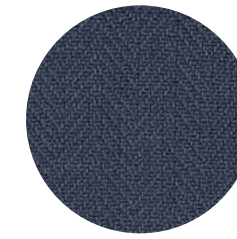

color: black
no: 100



color: floral check
no: 802



color: earth check
no: 801



color: ocean check
no: 803





KITCHEN TOWEL

GIFT SET I

GAVESÆT | GESCHENKSET | COFFRET CADEAU

Style no: TOC 1086
 Size: 53 x 86 cm, one set of 2 kitchen towels, 53 x 86 cm / 20.8 x 33.8"
 Weaving: Herringbone
 Material: 100% GOTS certified organic cotton
 MOQ: 8 sets

RRP
 DKK: 250,-
 EUR: 35.90
 NOK: 380,-
 SEK: 380,-
 USD-L: 44.00
 CAD-L: 58.00



A long lasting gift set for many occasions.
 Presentable, thoughtful and sustainable.

color: floral set color mix
 no: 952

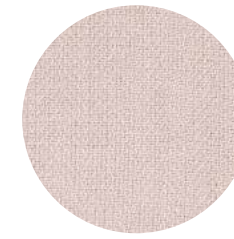

pale rose / 331

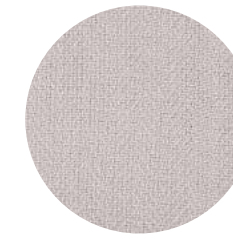

dusty lavender / 340

color: floral check color mix
 no: 812

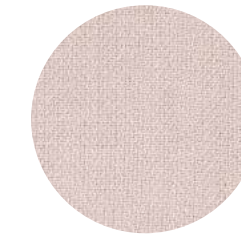

pale rose / 331



floral chec / 802

color: earth set color mix
 no: 951

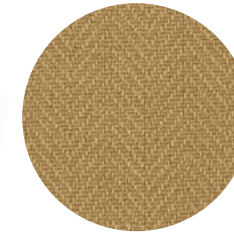

khaki / 215

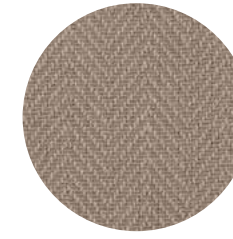

clay / 225

color: earth check color mix
 no: 811

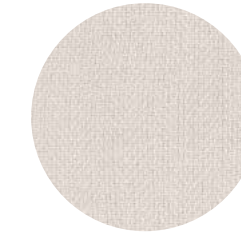

stone / 202



earth check / 801

color: ocean set color mix
 no: 953

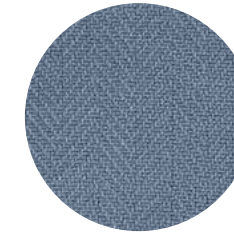

grey blue / 510

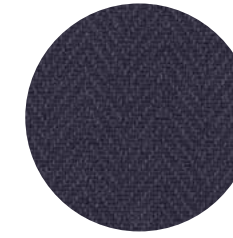

dark blue / 500

color: ocean check color mix
 no: 813

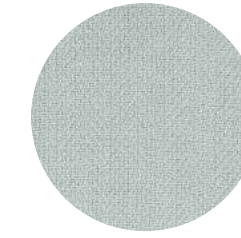

sky / 570



ocean check / 803

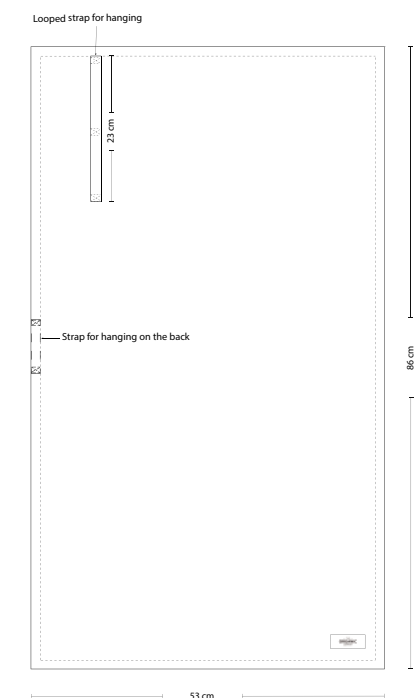



KITCHEN CLOTH

KITCHEN CLOTH

KARKLUD | ABWASCHTUCH | SERVIETTE DE INVITÉE

Style no: TOC 1048
Size: 30 x 35 cm / 11.8 x 13.8"
Weaving: Piqué
Material: 100% GOTS certified organic cotton
MOQ: 12 pieces

RRP
DKK: 65,-
EUR: 9,90
NOK: 95,-
SEK: 95,-
USD-L: 11.50
CAD-L: 15.50

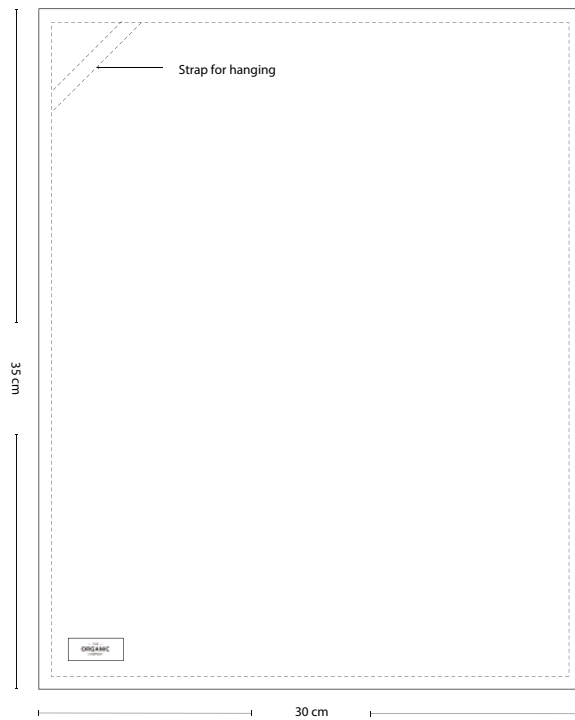

The Kitchen cloth has a unique ability to absorb liquid - isn't it the most important thing a dish cloth should be able to do?



color: stone coral
no: 380



color: morning grey
no: 180



color: stone rose
no: 330



color: evening grey
no: 111



color: stone khaki
no: 214



color: grey blue stone
no: 511



color: khaki stone
no: 216



color: dark blue stone
no: 550



color: clay stone
no: 226



NEW PRODUCT

KITCHEN CLOTH 3 PACK

KARKLUD | ABWASCHTUCH | SERVIETTE DE INVITÉE

Style no: TOC 1139
Size: 30 x 35 cm / 11.8 x 13.8", 3 pack
Weaving: Piqué
Material: 100% GOTS certified organic cotton
MOQ: 8 sets of 3 pieces

RRP
DKK: 190,-
EUR: 26.90
NOK: 280,-
SEK: 280,-
USD-L: 34.00
CAD-L: 44.00

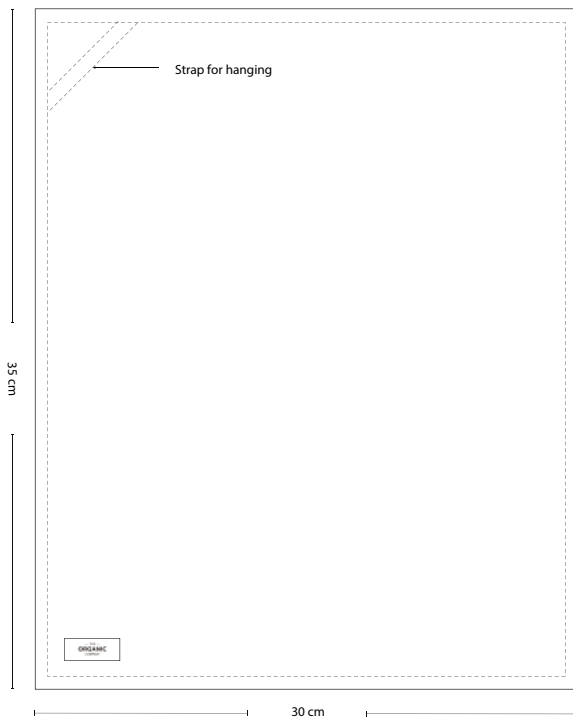

The Kitchen cloth has a unique ability to absorb liquid - isn't it the most important thing a dish cloth should be able to do?

color: evening grey
no: 933



color: morning grey
no: 180

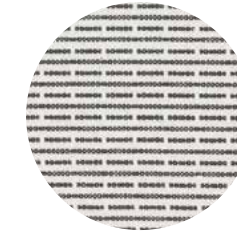

color: clay stone
no: 226



color: floral box
no: 932



stone coral / 380



stone rose / 330



khaki stone / 216

color: ocean box
no: 912

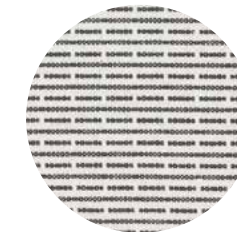

morning grey / 180



grey blue stone / 511



dark blue stone / 550

color: earth box
no: 931



clay stone / 226



stone khaki / 214



evening grey / 111

DISPLAY KITCHEN CLOTH

KARKLUD | ABWASCHTUCH | SERVIETTE DE INVITÉE

Style no: TOC 1097
 Size: 30 x 35 cm, display box with 48 pieces / 11.8 x 13.8"
 Weaving: Piqué
 Material: 100% GOTS certified organic cotton
 MOQ: 1 display box of 48 pieces

RRP
 DKK: 3120,-
 EUR: 475.20
 NOK: 4560,-
 SEK: 4560,-
 USD-L: 550.00
 CAD-L: 744.00



With a display box you combine stock with a nice product presentation - without taking up extra storage space - sustainable and presentable.

Buy one display box and get 8 kitchen cloths for free.

color: floral box
no: 932



stone khaki / 214

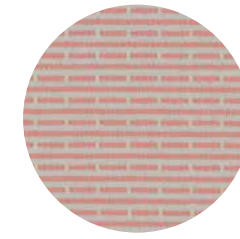

stone coral / 380



stone rose / 330

color: earth box
no: 931



stone khaki / 214



khaki stone / 216



clay stone / 226

color: graphic box
no: 930



morning grey / 180



clay stone / 226



dark blue stone / 550

color: ocean box
no: 933



grey blue stone / 511



evening grey / 111



black blue / 501

GIFT SET II

GAVESÆT | GESCHENKSET | COFFRET CADEAU

Style no: TOC 1087
 Size: One gift set contains 1 kitchen towel & 2 kitchen cloth
 Weaving: Piqué and herringbone
 Material: 100% GOTS certified organic cotton
 MOQ: 8 sets

RRP
 DKK: 250,-
 EUR: 35.90
 NOK: 380,-
 SEK: 380,-
 USD-L: 44.00
 CAD-L: 58.00



A long lasting gift set for many occasions.
 Presentable, thoughtful and sustainable.

color: floral selection
 no: 972

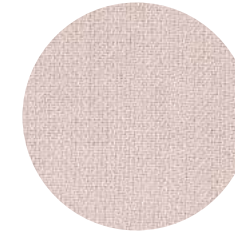

pale rose / 331

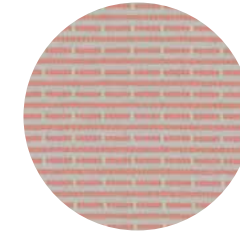

stone coral / 380



stone khaki / 214

color: ocean selection
 no: 973

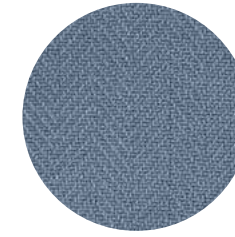

grey blue / 510



grey blue stone / 511



dark blue stone / 550

color: earth selection
 no: 971

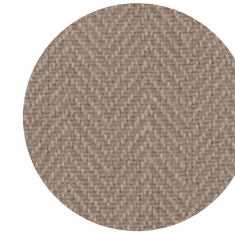

clay / 225



clay stone / 226



khaki stone / 216

Looped strap for hanging

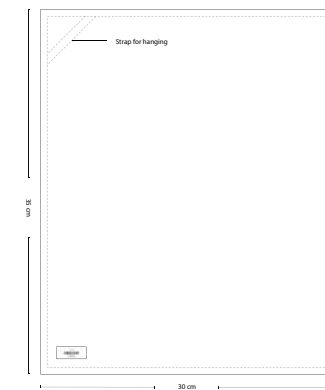
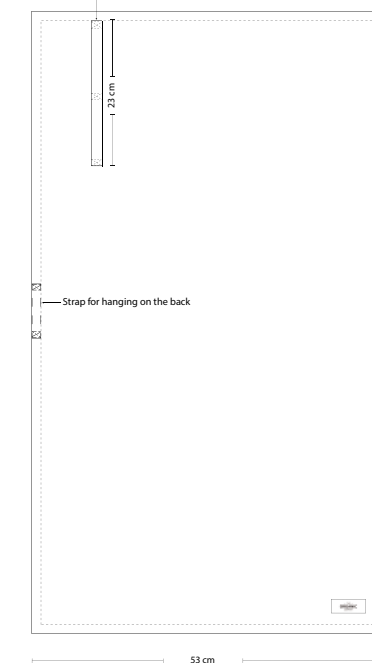

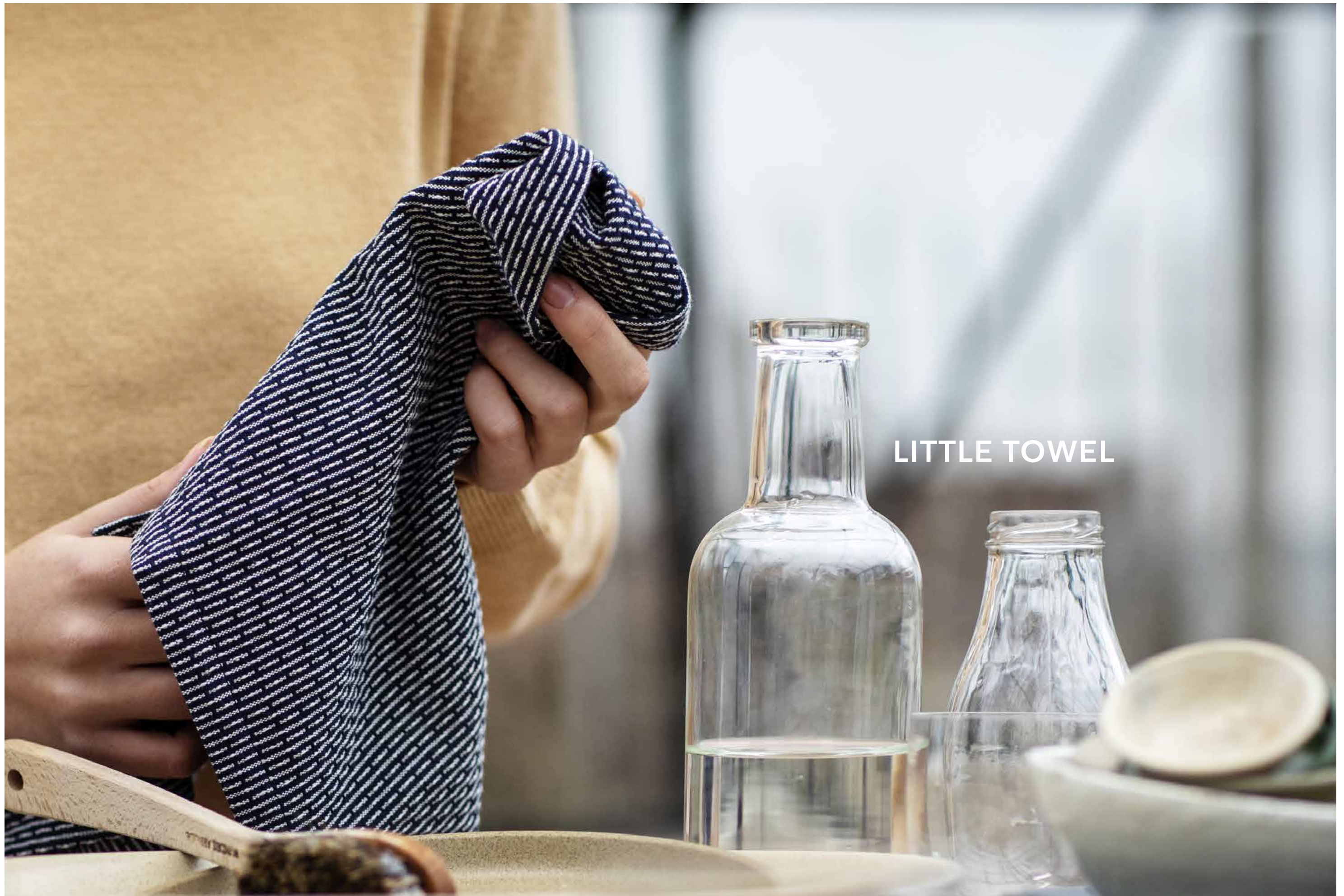

LITTLE TOWEL

LITTLE TOWEL

HÅNDKLÆDE | HANDTUCH | SERVIETTE

Style no: TOC 1078
 Size: 35 x 60 cm / 13.7 x 23.6"
 Weaving: Piqué
 Material: 100% GOTS certified organic cotton
 MOQ: 8 pieces

RRP
 DKK: 115,-
 EUR: 16.90
 NOK: 165,-
 SEK: 165,-
 USD-L: 21.00
 CAD-L: 26.00

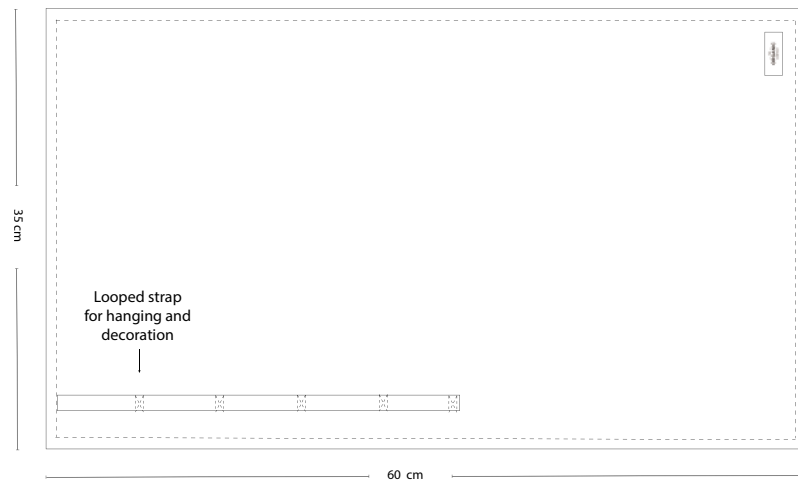

color: stone coral
no: 380

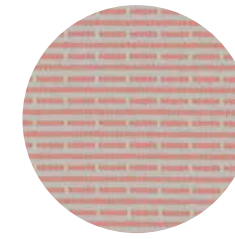

color: stone khaki
no: 214



color: morning grey
no: 180



color: stone rose
no: 330



color: khaki stone
no: 216



color: evening grey
no: 111



color: clay stone
no: 226



color: grey blue stone
no: 511



color: dark blue stone
no: 550



A little towel for use in the kitchen. Designed with high absorbency for daily situations. A beautiful combination of design and functionality.



TEA BAG

TEA BAG

TEPOSE | TEEBEUTEL | SACHET DE THÉ

color: undyed
no: 201



TEA BAG SET

Style no: TOC 1070 / Tea bag set
Size: Box of 1 piece small, 1 pieces medium,
1 teak tree stick (wastage)
Weaving: Plain voile
Material: 100% GOTS certified organic cotton /
food-approved material
MOQ: 8 boxes

RRP

DKK: 140,-
EUR: 19.90
NOK: 200,-
SEK: 200,-
USD-L: 25.00
CAD-L: 34.00

TEA BAG SMALL

Style no: TOC 1072 / Tea bag small
Size: 8 x 10 cm / 3.1 x 3.9"
Weaving: Plain voile
Material: 100% GOTS certified organic cotton /
food-approved material
MOQ: 16 pieces

RRP

DKK: 30,-
EUR: 3.90
NOK: 45,-
SEK: 45,-
USD-L: 6.00
CAD-L: 8.00

TEA BAG MEDIUM

Style no: TOC 1071 / Tea bag medium
Size: 9 x 14 cm / 3.5 x 5.5"
Weaving: Plain voile
Material: 100% GOTS certified organic cotton /
food-approved material
MOQ: 16 pieces

RRP

DKK: 35,-
EUR: 4.9
NOK: 50,-
SEK: 50,-
USD-L: 7.0
CAD-L: 9.0

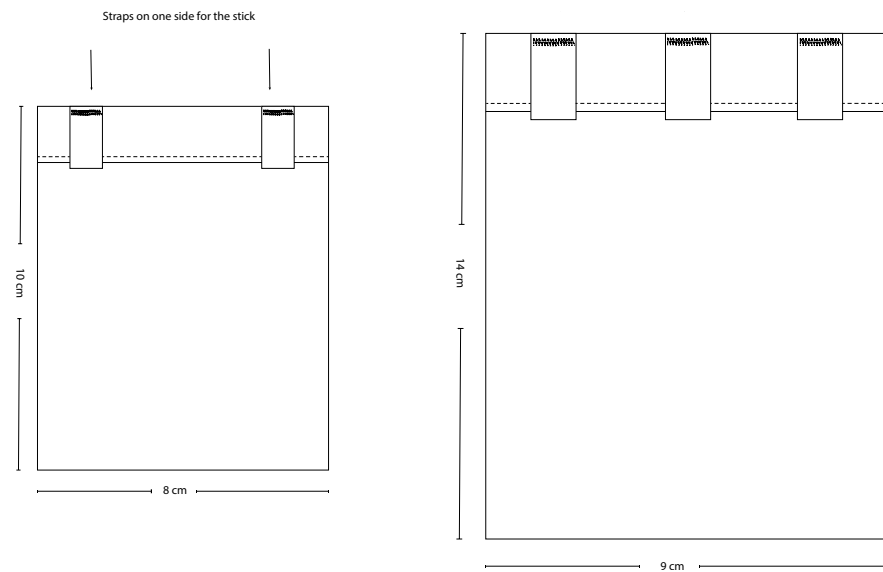

Did you know that millions of tea bags are used once and dumped daily? Replace single-use tea bags and enjoy your favorite tea in this reusable tea bag. Made in organic food-approved and unbleached cotton for a cleaner cup of tea. What is your choice?



FOOD BAG

FOOD BAG

MADPOSE | ESSEN BEUTEL | SAC DE NOURRITURE

SMALL

Style no: **TOC 1049**
 Size: **16 x 22 x 6 cm / 2.3 x 6.3 x 8.7"**
 Weaving: **Gauze**
 Material: **100% GOTS certified organic cotton / food-approved material**
 MOQ: **16 pieces**

RRP

DKK: **40,-**
 EUR: **5.90**
 NOK: **55,-**
 SEK: **55,-**
 USD-L: **8.00**
 CAD-L: **10.00**

MEDIUM

Style no: **TOC 1050**
 Size: **24 x 30 x 8 cm / 9.4 x 11.8 x 3.1"**
 Weaving: **Gauze**
 Material: **100% GOTS certified organic cotton / food-approved material**
 MOQ: **16 pieces**

RRP

DKK: **45,-**
 EUR: **6.90**
 NOK: **65,-**
 SEK: **65,-**
 USD-L: **9.00**
 CAD-L: **12.00**

LARGE

Style no: **TOC 1051**
 Size: **30 x 40 x 12 cm / 11.8 x 15.7 x 4.7"**
 Weaving: **Gauze**
 Material: **100% GOTS certified organic cotton / food-approved material**
 MOQ: **16 pieces**

RRP

DKK: **55,-**
 EUR: **7.90**
 NOK: **80,-**
 SEK: **80,-**
 USD-L: **10.00**
 CAD-L: **13.00**

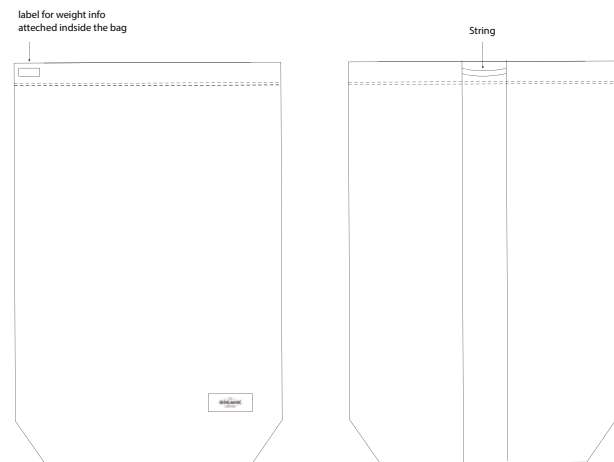

Did you know that we use around 2 million single use plastic bags every minute, on a global scale? Replace plastic and have your food contained organically with our Food bags. Made in organic food-approved cotton.

What is your choice?



color: **natural white**
 no: **200**



color: **stone**
 no: **202**

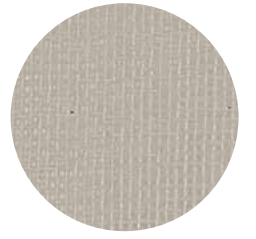

color: **maroon**
 no: **390**



NEW COLOR

color: **khaki**
 no: **215**

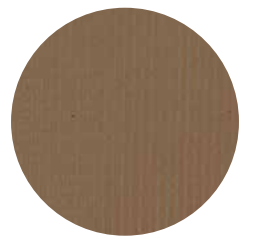

color: **dark green**
 no: **400**

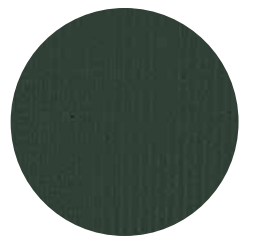

FOOD BAG SET

MADPOSE | ESSEN BEUTEL | SAC DE NOURRITURE

Style no: TOC 1116

Size: One set of 3 pcs. S, M, L

16 x 22 x 6 cm / 2.3 x 6.3 x 8.7"

24 x 30 x 8 cm / 3.1 x 9.4 x 11.8"

30 x 40 x 12 cm / 4.7 x 11.8 x 15.7"

Weaving: Gauze

Material: 100% GOTS certified organic cotton / food-approved material

MOQ: 8 sets

RRP

DKK: 130,-

EUR: 18.90

NOK: 185,-

SEK: 185,-

USD-L: 24.00

CAD-L: 32.00

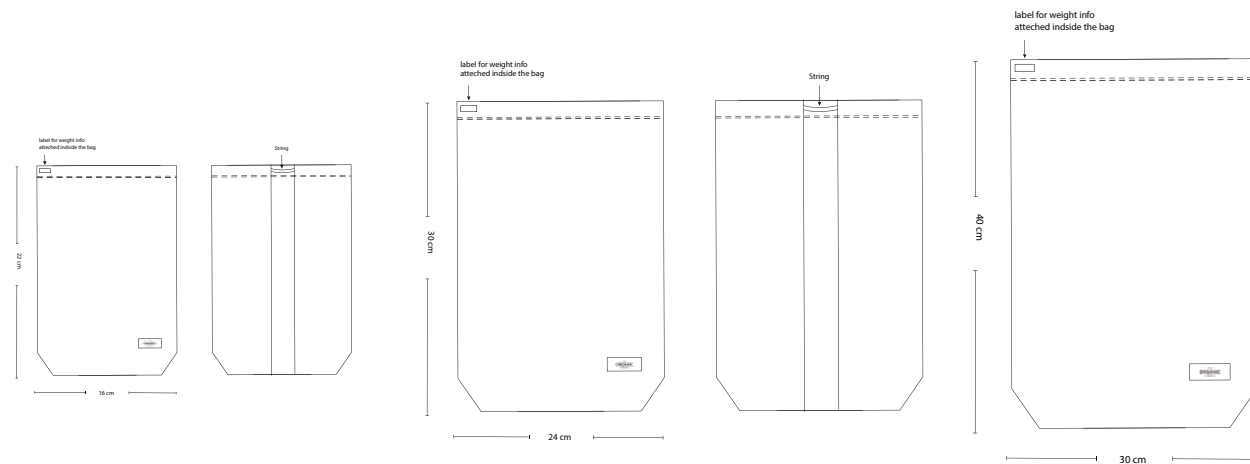

The Food Bag is designed with special care for people and the environment. The bag is a reusable alternative to disposable packaging. Use it for shopping and storing bulk goods like fruit and vegetables. String for hanging, carrying and closure. Made in organic food-approved cotton.



color: natural white
no: 200



NEW COLOR

color: stone
no: 202

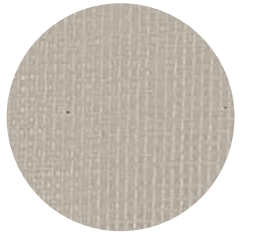

color: maroon
no: 390



NEW COLOR

color: khaki
no: 215

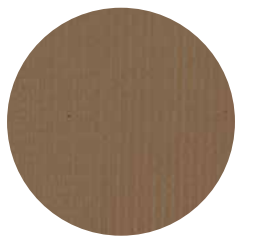

NEW COLOR

color: dark green
no: 400

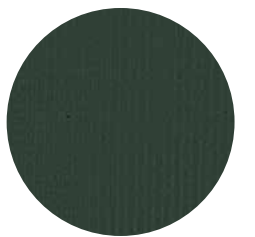

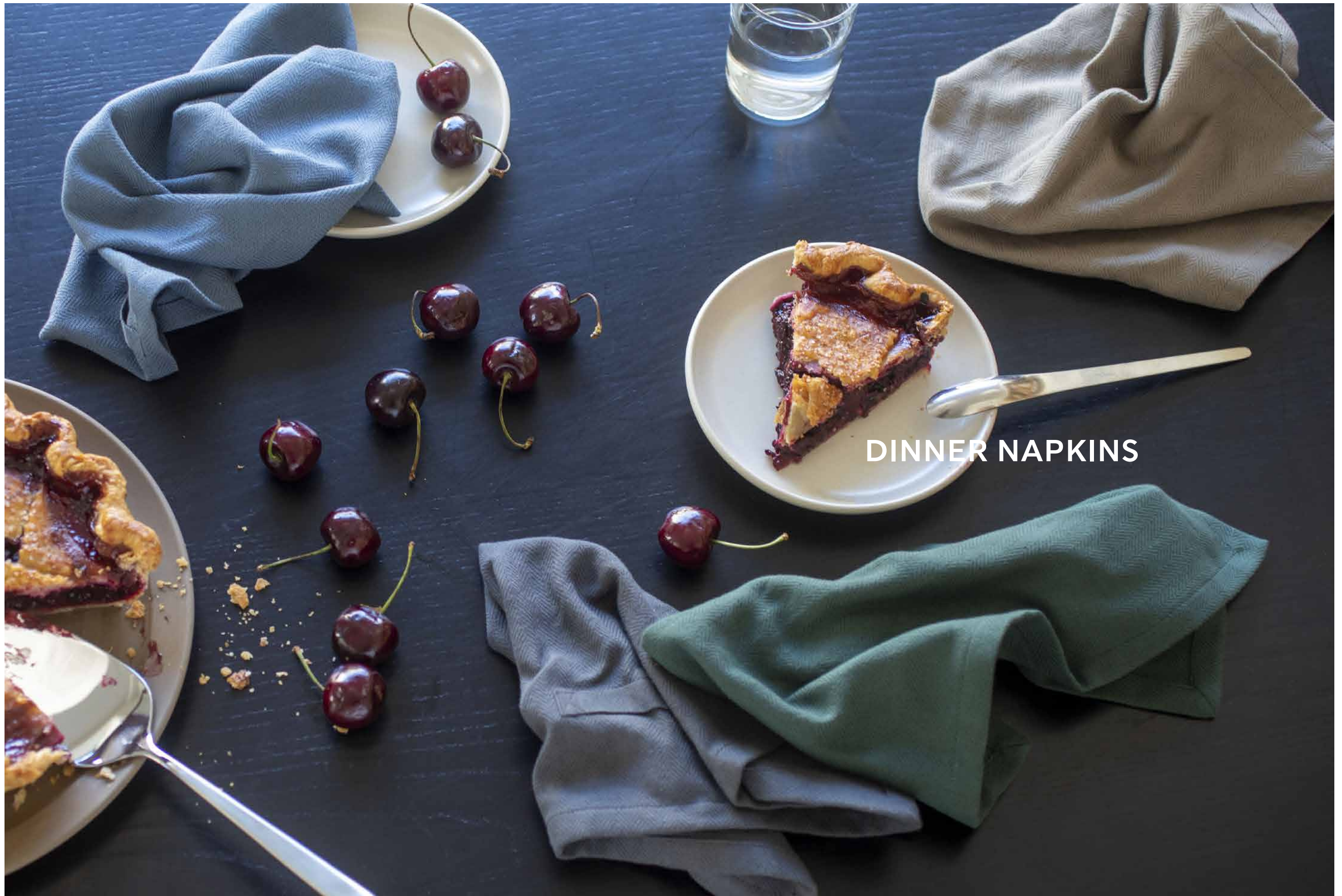

DINNER NAPKINS

NEW PRODUCT

DINNER NAPKINS

SERVIET | STOFFSERVIETTE | SERVIETTE

Style no: TOC 1134
Size: 35 x 40 cm / 13.8 x 15.7", box of 4 pieces
Weaving: Herringbone
Material: 100% GOTS certified organic cotton
MOQ: 8 sets of 4 pieces

RRP
DKK: 185,-
EUR: 25.90
NOK: 270,-
SEK: 270,-
USD-L: 32.00
CAD-L: 42.00

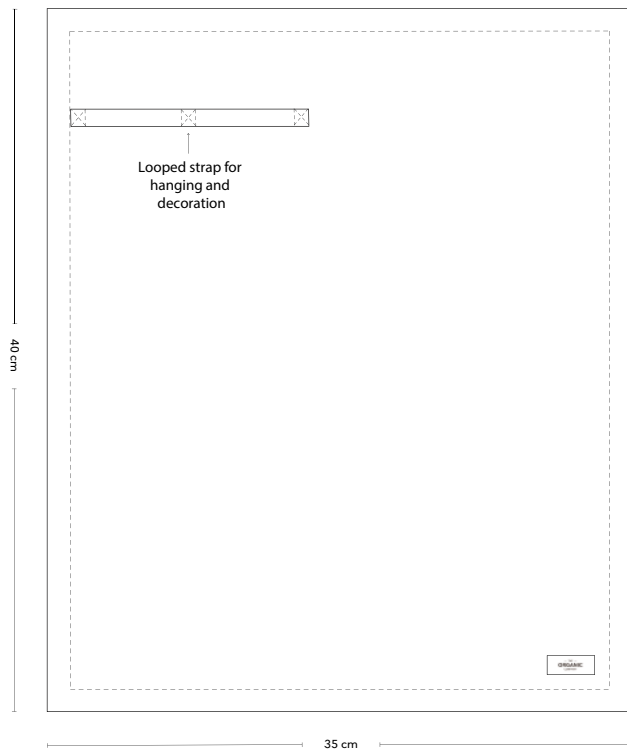

color: natural white
no: 200



color: clay
no: 225

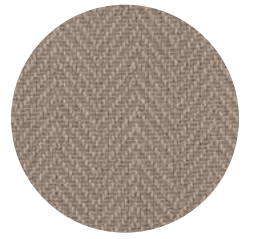

color: stone
no: 202



color: grey blue
no: 510

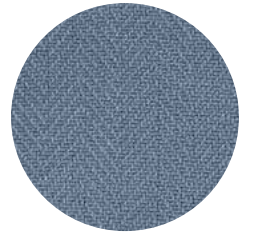

color: dusty mint
no: 410

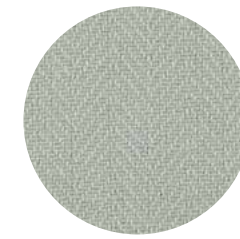

color: dark blue
no: 500

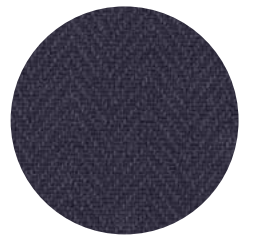

color: dark green
no: 400

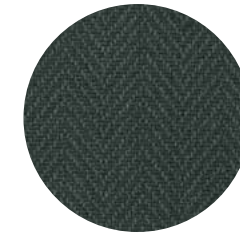

color: dark grey
no: 110

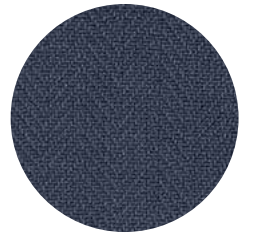

Millions of trees every year are used for single-use purposes.
Replace disposable paper with our Dinner Napkins.
What is your choice?

EVERYDAY NAPKIN

SERVIET | STOFFSERVIETTE | SERVIETTE

Style no: TOC 1073
 Size: 20 x 20 cm, box of 4 pieces / 7.9 x 7.9"
 Weaving: Herringbone
 Material: 100% GOTS certified organic cotton
 MOQ: 8 boxes

RRP
 DKK: 160,-
 EUR: 22.90
 NOK: 235,-
 SEK: 235,-
 USD-L: 28.00
 CAD-L: 36.00

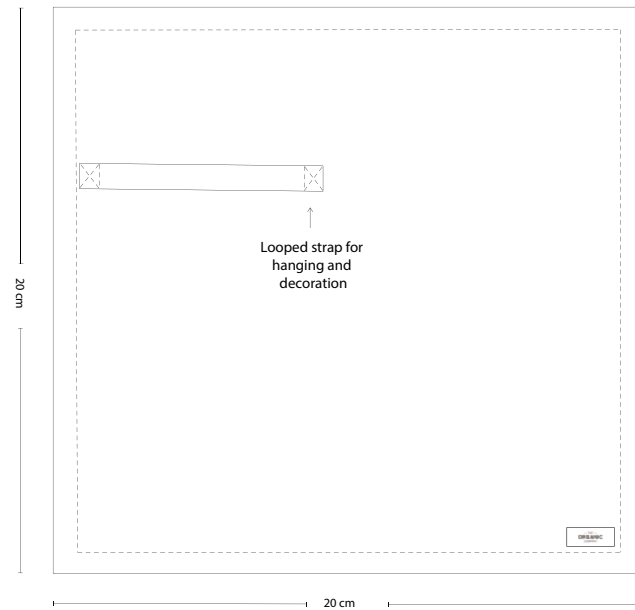
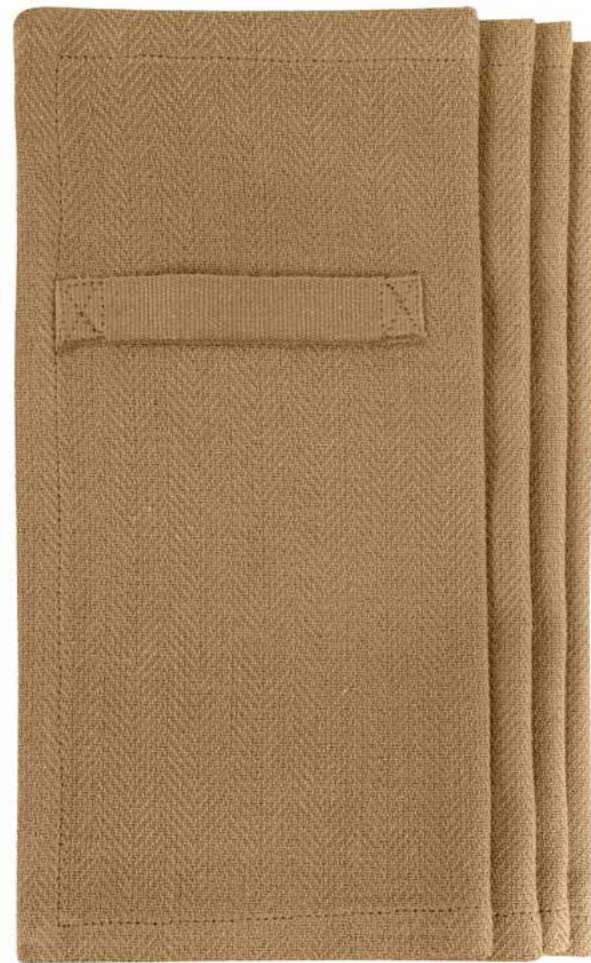

color: floral color mix
no: 902



color: earth color mix
no: 901



color: ocean color mix
no: 903



color: stone
no: 202

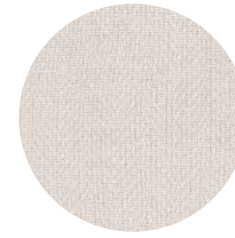

color: pale yellow
no: 210



NEW COLOR

color: sky
no: 570

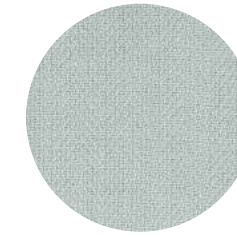

NEW COLOR

color: natural white
no: 200



color: dusty lavender
no: 340

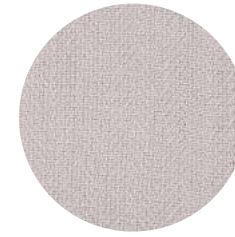

NEW COLOR

color: khaki
no: 215

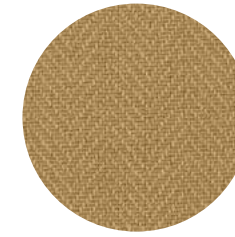

color: grey blue
no: 510

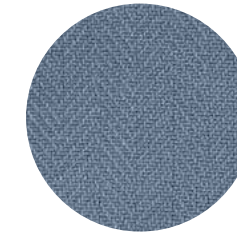

NEW COLOR

color: dusty mint
no: 410

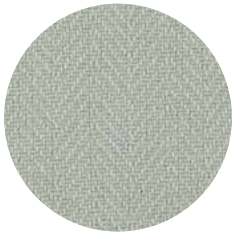

NEW COLOR

color: pale rose
no: 331

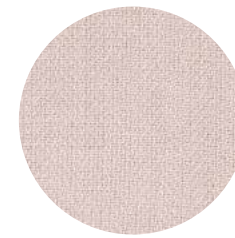

color: clay
no: 225

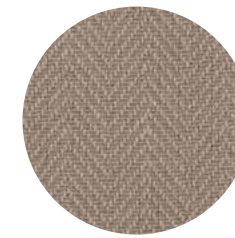

color: dark blue
no: 500

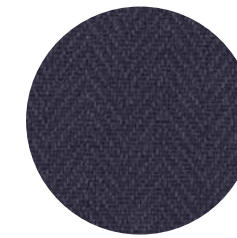

color: dark green
no: 400



color: coral
no: 385

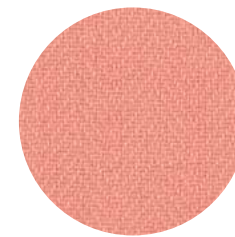

NEW COLOR

color: maroon
no: 390



NEW COLOR

color: dark grey
no: 110

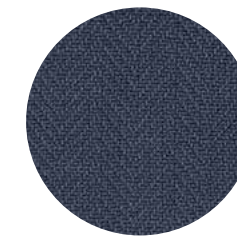

Millions of trees every year are used for single-use purposes. Amongst other, as paper towels and papernapkins. Let's reuse much more. Our Everyday napkin is designed as a practical and nice piece to replace disposable paper in many everyday situations. What is your choice?



LUNCH BAG

LUNCH BAG

MADPAKKEPOSE | LUNCHPAKET | SAC À LUNCH

Style no: TOC 1052
Size: 30 x 39 x 12 cm / 4.7 x 11.8 x 15.3"
Weaving: Heavy canvas
Material: 100% GOTS certified organic cotton
MOQ: 6 pieces

RRP

DKK: 140,-
EUR: 19.90
NOK: 200,-
SEK: 200,-
USD-L: 25.00
CAD-L: 34.00

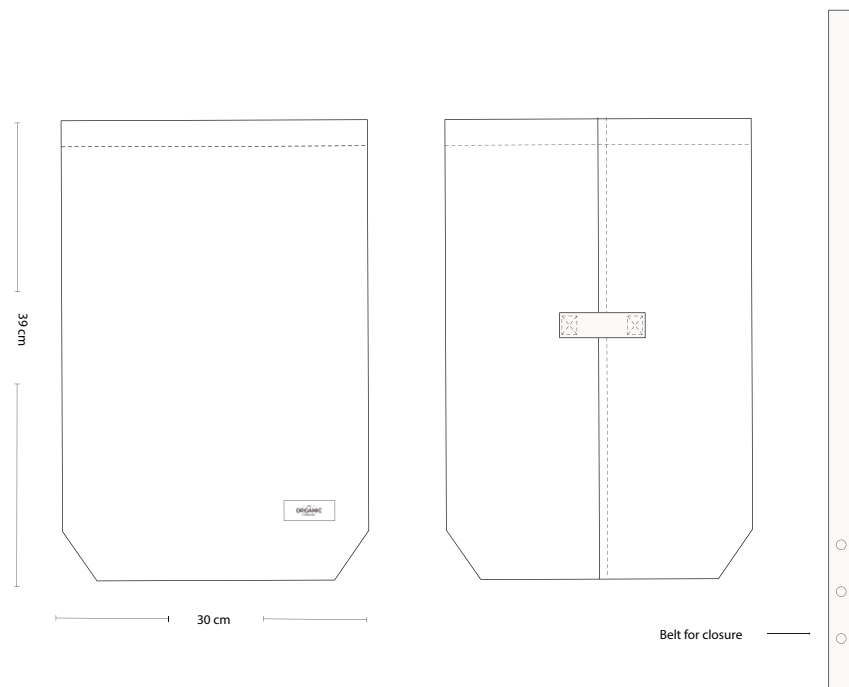

color: stone
no: 202

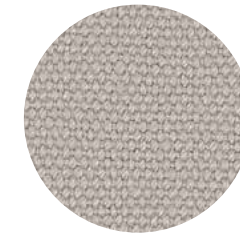

color: clay
no: 225

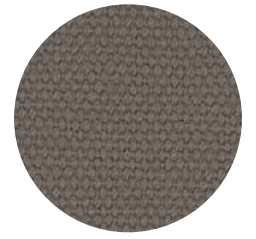

color: grey blue
no: 510

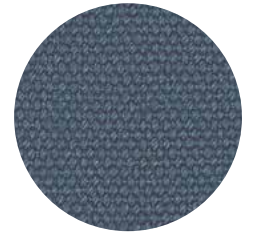

color: dark blue
no: 500



color: dark grey
no: 110



color: dark green
no: 400

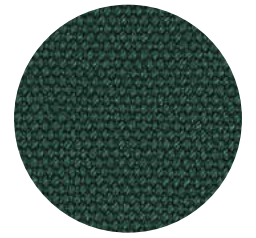

This bag is designed to contain your delicious lunch. It is made from organic cotton and is meant to replace disposable bags.

What is your choice?

TEA COSY

TEHÆTTE | TEKANNENHAUBE | COUVRE-THÉIÈRE

Style no: TOC 1034
Size: 36 x 30 cm / 11.8 x 12.6"
Weaving: Piqué cotton wadding
Material: 100% GOTS certified organic cotton
MOQ: 4 pieces

RRP
DKK: 295,-
EUR: 41.90
NOK: 425,-
SEK: 425,-
USD-L: 52.00
CAD-L: 66.00

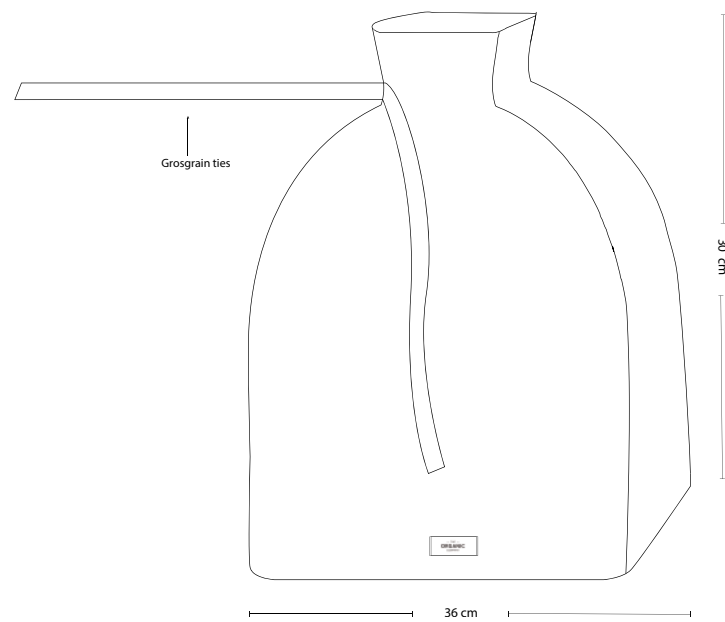

Enjoy your tea and keep it warm for longer. This tea cosy is made with insulating cotton wadding in pure and certified organic cotton.

Delicate yet practical - as part of our range of great kitchen accessories.



color: morning grey
no: 180



color: grey blue stone
no: 511



color: dark blue stone
no: 550



NEW COLOR

color: evening grey
no: 111



color: clay stone
no: 226



color: stone rose
no: 330

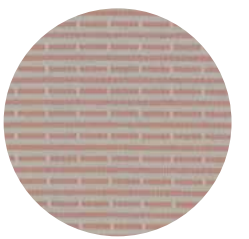

COFFEE COSY

KAFFEVARMER | KAFFEEKANNENHAUBE | CHAUFFE-CAFETIÈRE

Style no: TOC 1032
Size: 26 x 36 cm / 10.2 x 14.2"
Weaving: Piqué or canvas, cotton wadding
Material: 100% GOTS certified organic cotton
MOQ: 4 pieces

RRP
DKK: 295,-
EUR: 41.90
NOK: 425,-
SEK: 425,-
USD-L: 52.00
CAD-L: 66.00

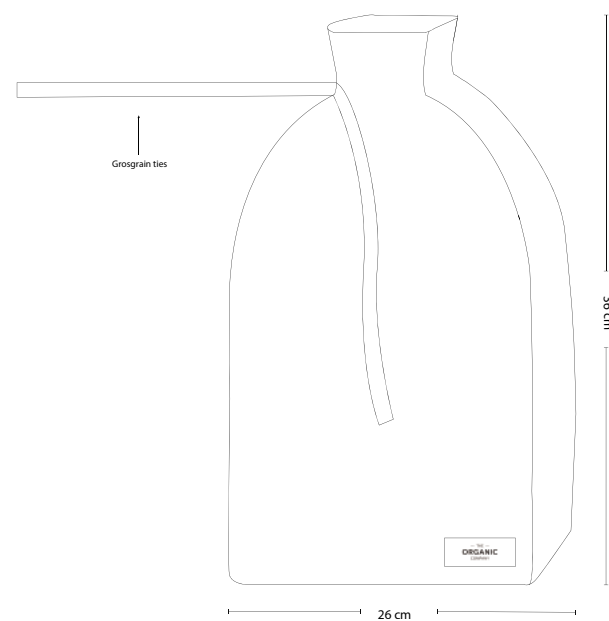

Enjoy your favorite coffee and keep it warm for longer. This coffee is made with insulating cotton wadding in pure and certified organic cotton.

Delicate yet practical - as part of our range of great kitchen accessories.



color: morning grey
no: 180

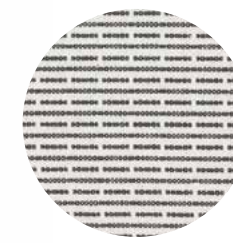

color: evening grey
no: 111

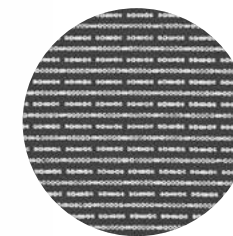

color: black
no: 100



OVEN GLOVES

GRYDELAPPER | OFENHANDSCHUHE | MANIQUES

Style no: TOC 1035
Size: 22 x 100 cm / 8.7 x 39.4"
Weaving: Piqué or canvas, cotton wadding
Material: 100% GOTS certified organic cotton
MOQ: 4 pieces

RRP
DKK: 295,-
EUR: 41.90
NOK: 425,-
SEK: 425,-
USD-L: 52.00
CAD-L: 66,-

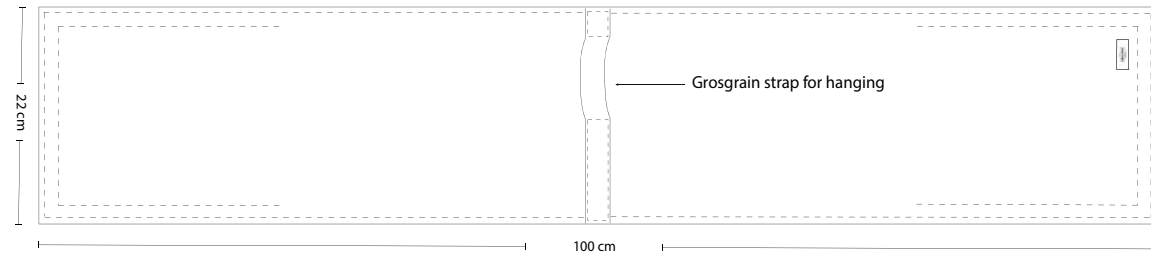

When cooking delicious food, your kitchen accessories needs to be in order. Protect your hands and arms while working with heat in the kitchen - and do this with distinct design and in 100% organic cotton.



color: morning grey
no: 180



color: grey blue stone
no: 511



color: evening grey
no: 111



color: black
no: 100





OVEN MITTS

OVEN MITTS

OVNHANDSKER | OFENHANDSCHUHE | GANTS DE CUISINE

MEDIUM

Style no: TOC 1046
Size: 15 x 31 cm / 5.9 x 12.2"
Weaving: Canvas, cotton wadding
Material: 100% GOTS certified organic cotton
MOQ: 4 pieces

LARGE

Style no: TOC 1047
Size: 17 x 36 cm / 6.6 x 14.2"
Weaving: Canvas, cotton wadding
Material: 100% GOTS certified organic cotton
MOQ: 4 pieces

RRP

DKK: 295,-
EUR: 41.90
NOK: 425,-
SEK: 425,-
USD-L: 52.00
CAD-L: 66.00

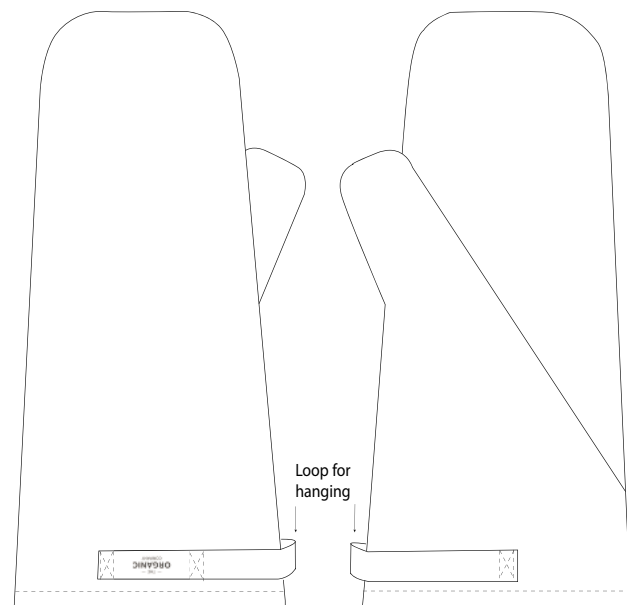

When cooking delicious food, your kitchen accessories need to be in order. Protect your hands and arms while working with heat in the kitchen - and do this with distinct design and in 100% organic cotton.



color: khaki
no: 215



color: clay
no: 225

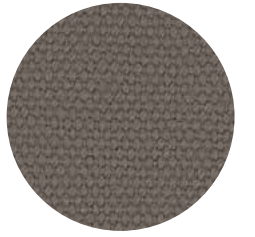

color: grey blue
no: 510

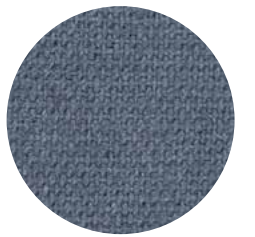

NEW COLOR

color: dark grey
no: 110



color: black
no: 100



CREATIVE AND GARDEN APRON

FORKLÆDE | SCHÜRZE | TABLIER

Style no: TOC 1031
Size: 100 x 74 cm / 39.4 x 29.0"
Weaving: Canvas
Material: 100% GOTS certified organic cotton
MOQ: 4 pieces

RRP
DKK: 335,-
EUR: 47.90
NOK: 485,-
SEK: 485,-
USD-L: 59.00
CAD-L: 75.00

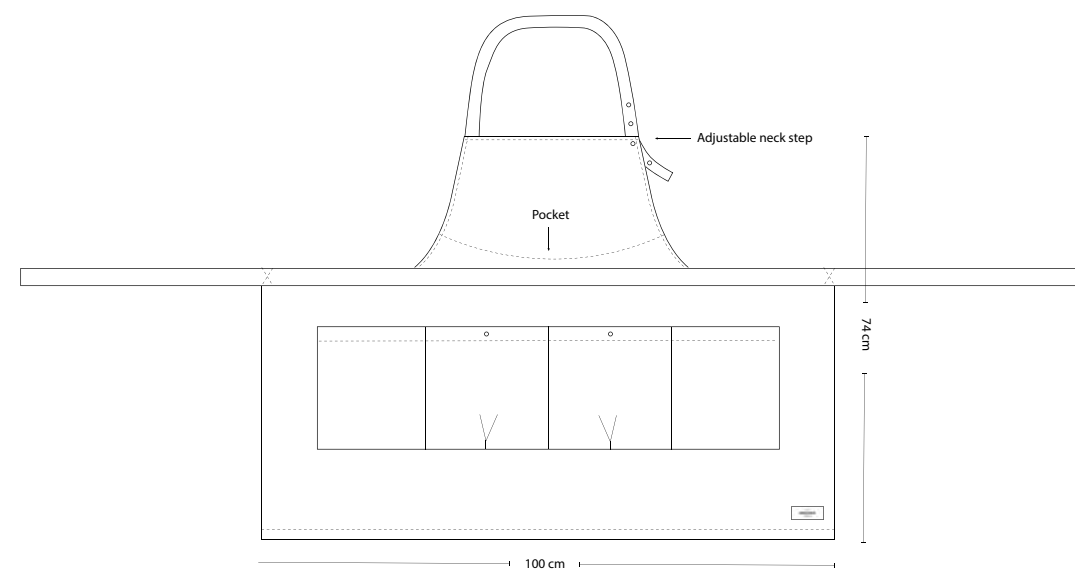

Backyard, studio, kitchen...wherever you are, this apron has you covered. It's made from 100% certified organic cotton, in a canvas weave that's tough enough for even your most messy projects. Comes with 5 practical pockets to keep your tools close at hand.



color: dusty mint
no: 410

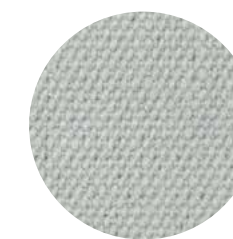

NEW COLOR

color: clay
no: 225

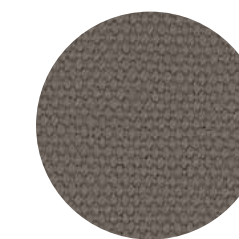

color: dark blue
no: 500



color: dark green
no: 400

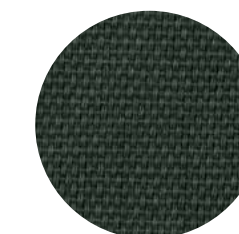

color: dark grey
no: 110



color: black
no: 100

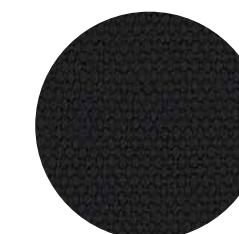

APRON WITH POCKET

FORKLÆDE | SCHÜRZE | TABLIER

Style no: TOC 1037
Size: 80 x 95 cm / 30.7 x 37.4"
Weaving: Twill drill
Material: 100% GOTS certified organic cotton
MOQ: 4 pieces

RRP
DKK: 300,-
EUR: 42.90
NOK: 440,-
SEK: 440,-
USD-L: 54.00
CAD-L: 70.00

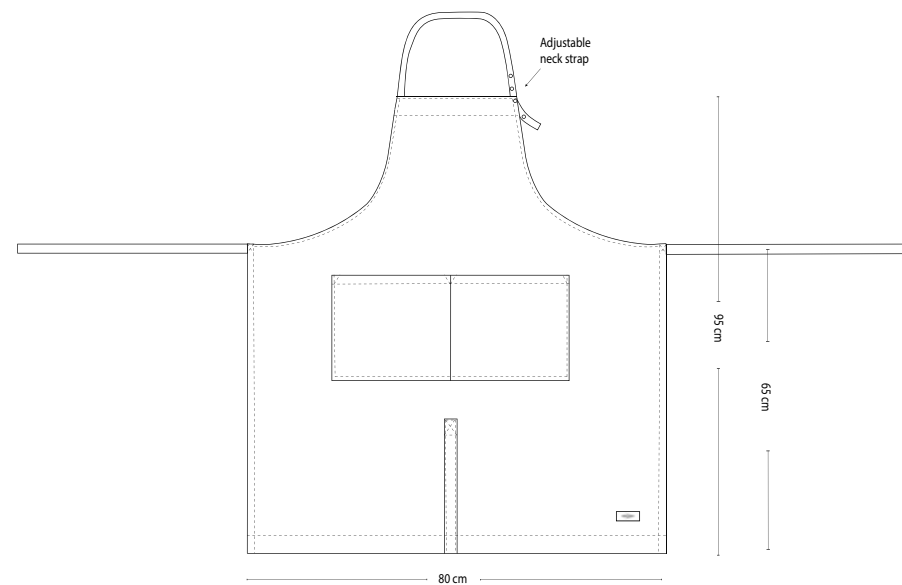

A practical apron in many different situations;
cooking at home, servicing customers, cleaning.



color: clay
no: 225

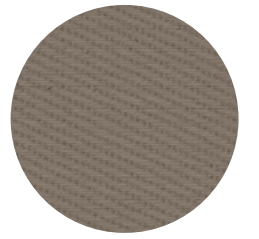

color: dark blue
no: 500



color: dark green
no: 400

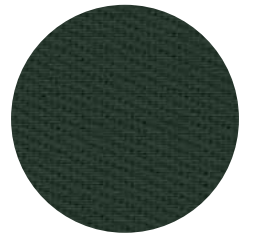

color: dark grey
no: 110

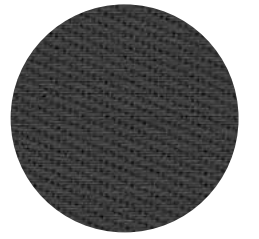

color: black
no: 100

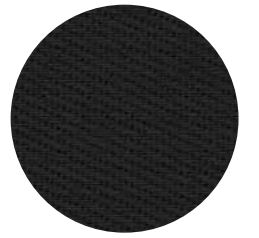



GIANT KITCHEN TOWEL

GIANT KITCHEN TOWEL

FORKLÆDE | SCHÜRZE | TABLIER

Style no: TOC 1039
Size: 60 x 155 cm / 23.6 x 61.0"
Weaving: Herringbone
Material: 100% GOTS certified organic cotton
MOQ: 4 pieces

RRP
DKK: 290,-
EUR: 40.90
NOK: 410,-
SEK: 410,-
USD-L: 49.00
CAD-L: 65.00

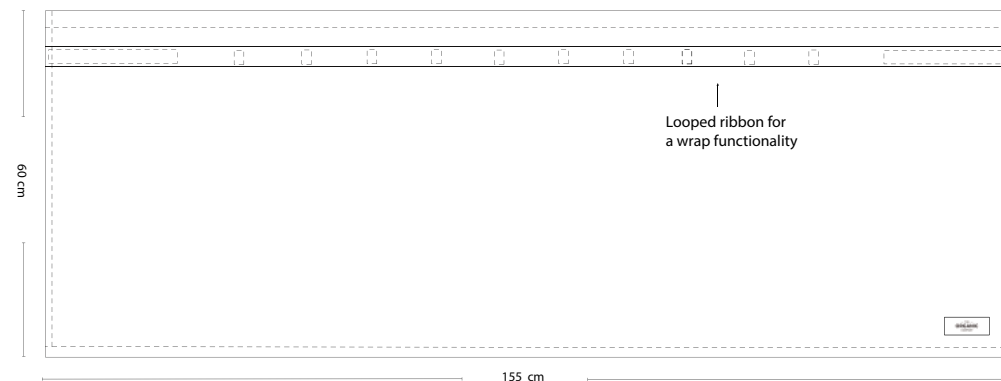

color: dusty mint
no: 410

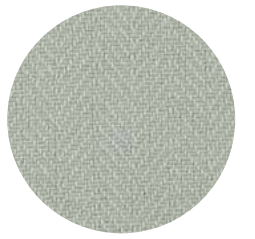

NEW COLOR

color: grey blue
no: 510

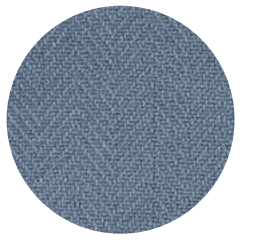

NEW COLOR

color: dark grey
no: 110

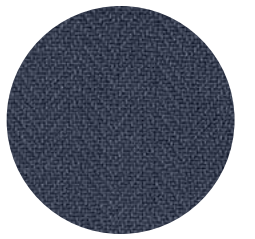

color: dusty lavender
no: 340

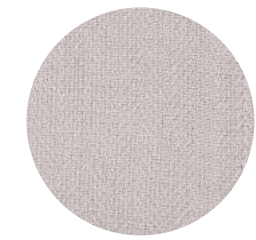

NEW COLOR

color: black
no: 100



color: coral
no: 385

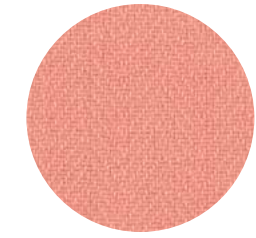

color: clay
no: 225

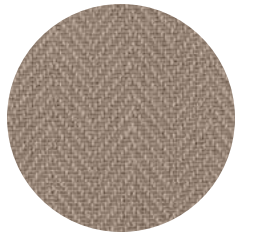

Use our Giant kitchen towel for your dishes or wrap it around you to look nice and practical when you cook, bake or grill. Designed to be practical.



BATH AND
WELLNESS

FINE INTRO

Please welcome FINE, our new towel series.

FINE encompasses our Nordic traditions with elements of light materials and soft color tones.

FINE is designed to be a light and “flowy” towel for your hands, hair and body.

This towel series will lift the look and feel in your bathroom and is also easy to roll up and bring with you on the go.

The essence of FINE is best described as freedom and weightlessness with the wonderful combination of 3 layers of lightweight gauze, soft color tones and unconventional towel sizes.

Our FINE towels have a great absorbency and dries quickly.



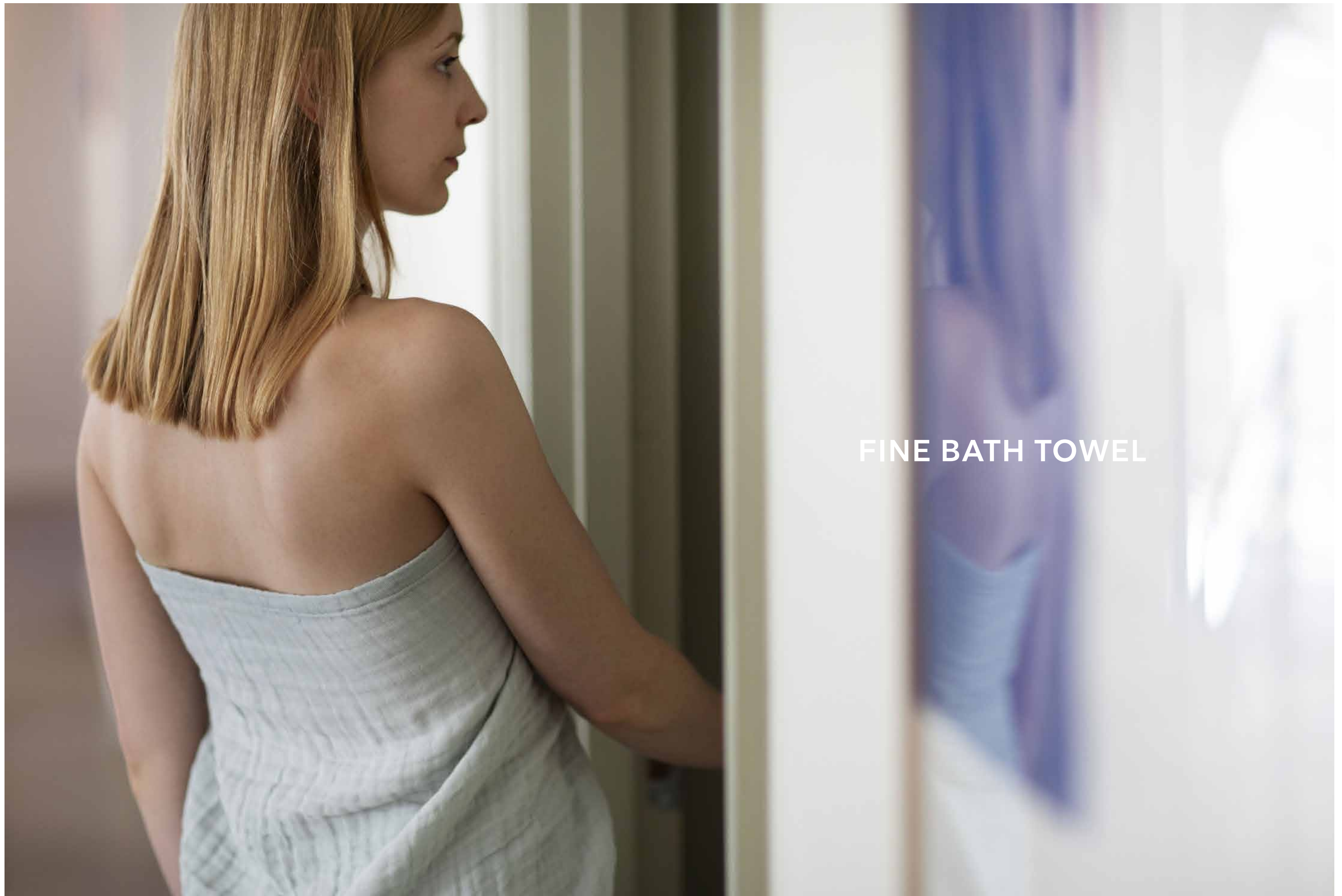

FINE BATH TOWEL

NEW PRODUCT

FINE BATH TOWEL

HÅNDKLÆDE | HANDTUCH | SERVIETTE DE BAIN

Style no: TOC 1130
Size: 100 x 150 cm / 39.4 x 59.0"
Weaving: Gauze
Material: 100% GOTS certified organic cotton
MOQ: 4 pieces

RRP

DKK: 345,-
EUR: 48.90
NOK: 490-
SEK: 490,-
USD-L: 60.00
CAD-L: 75.00

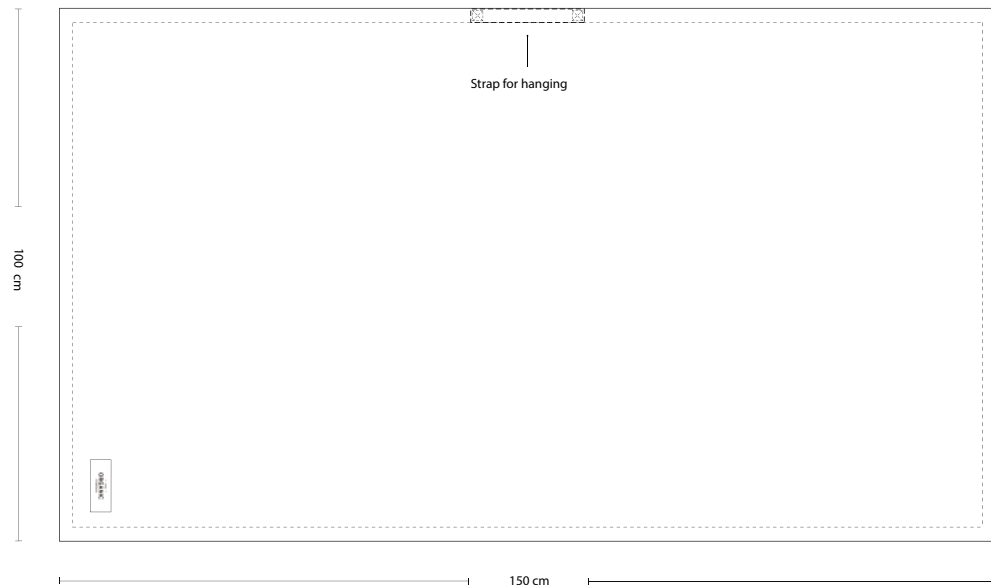

color: stone
no: 202

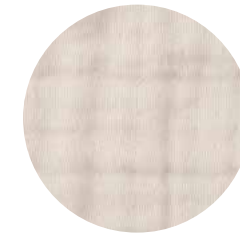

color: pale yellow
no: 210



color: dusty lavender
no: 340

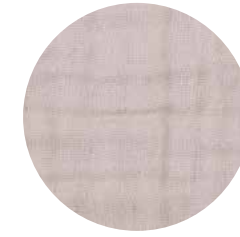

color: sky
no: 570

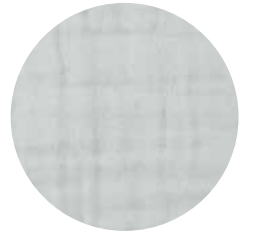

color: dusty mint
no: 410

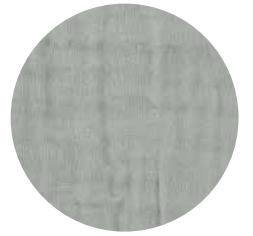

color: grey blue
no: 510



color: clay
no: 225



Experience freedom and weightlessness with the combination of 3 layers of lightweight gauze, soft color tones and unconventional towel sizes for your hands, hair and body. Light, beautiful, and fast drying. A bath towel with a true and pure flowy feeling.

NEW PRODUCT

FINE HAND TOWEL

HÅNDKLÆDE | HANDTUCH | SERVIETTE DE BAIN

Style no: TOC 1131
Size: 60 x 100 cm / 23.6 x 39.4"
Weaving: Gauze
Material: 100% GOTS certified organic cotton
MOQ: 4 pieces

RRP
DKK: 175,-
EUR: 24.90
NOK: 245,-
SEK: 245,-
USD-L: 35.00
CAD-L: 45.00

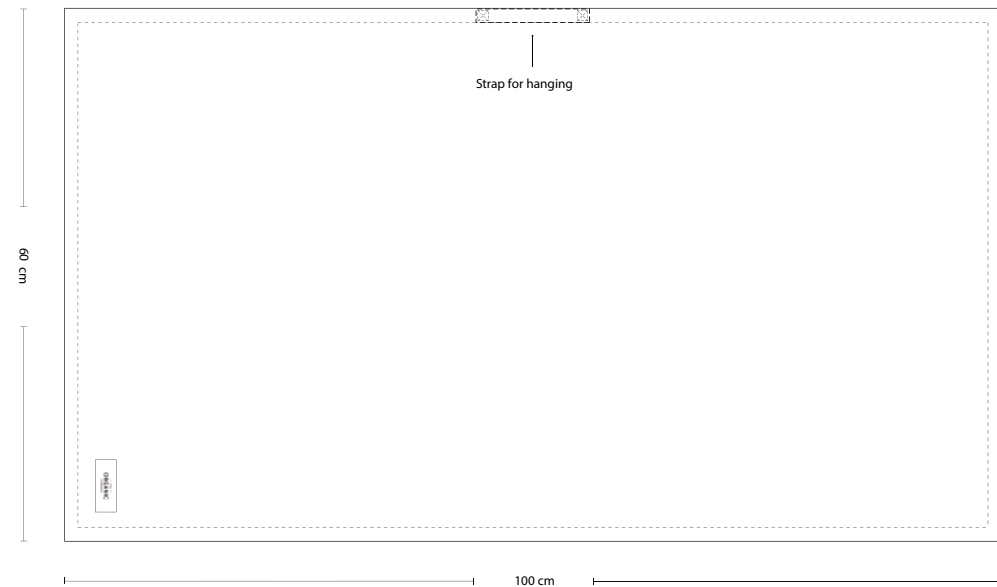

Experience freedom and weightlessness with the combination of 3 layers of lightweight gauze, soft color tones and unconventional towel sizes for your hands, hair and body. Light, beautiful, and fast drying. A hand towel with a true and pure flowy feeling.



color: pale yellow
no: 210

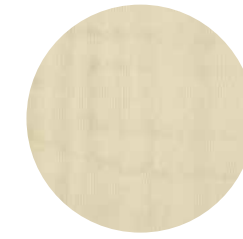

color: sky
no: 570



color: stone
no: 202

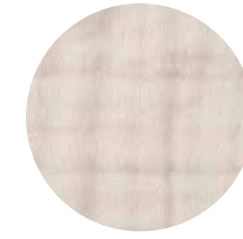

color: dusty mint
no: 410

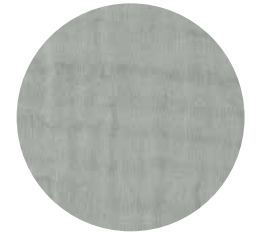

color: dusty lavender
no: 340

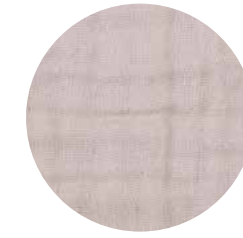

color: grey blue
no: 510



color: clay
no: 225



CALM INTRO

CALM is developed to merge practicality, luxury and design.

We wanted to design a terry series with an outstanding look - proving itself on an everyday basis. With the two-sided combination of terry and plain weave and subtle design details, the CALM series is designed for an easy lifestyle both at home and on the go.

Go for a clean Nordic design combined with high absorbency. Mix different colors together or mix with styles from our BIG WAFFLE or WELLNESS series for the perfectly imperfect look.

Each CALM product is designed with a strap or looped band for easy hanging. The bath towel is enhanced with a wrap functionality - to solve the awkwardness of a towel falling down, when you trust it to stay.



CALM TOWEL TO WRAP

HÅNDKLÆDE | HANDTUCH | SERVIETTE DE BAIN

Style no: **TOC 1088**
 Size: **70 x 160 cm / 27.5 x 63.0"**
 Weaving: **Terry plain**
 Material: **100% GOTS certified organic cotton**
 MOQ: **4 pieces**

RRP
 DKK: **455,-**
 EUR: **64.90**
 NOK: **660,-**
 SEK: **660,-**
 USD-L: **80.00**
 CAD-L: **108.00**

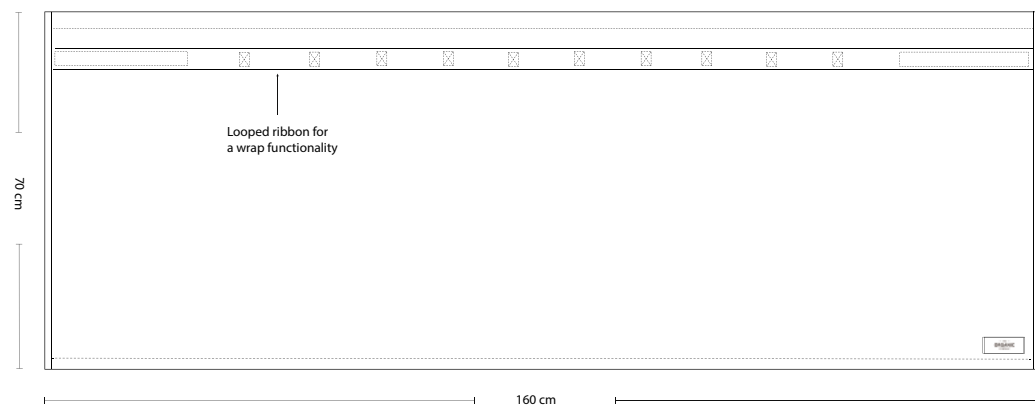

This organic two-sided terry/plain weave bath towel is designed to provide both comfort and functionality with its perfect wrap functionality.



color: **natural white**
no: **200**



color: **khaki**
no: **215**



color: **stone**
no: **202**



color: **clay**
no: **225**



color: **dusty lavender**
no: **340**



color: **dark grey**
no: **110**



color: **grey blue**
no: **510**



CALM TOWEL TO GO

HÅNDKLÆDE | HANDTUCH | SERVIETTE DE BAIN

Style no: TOC 1082
 Size: 60 x 120 cm / 23.6 x 47.2"
 Weaving: Terry plain
 Material: 100% GOTS certified organic cotton
 MOQ: 4 pieces

RRP
 DKK: 285,-
 EUR: 40.90
 NOK: 410,-
 SEK: 410,-
 USD-L: 52.00
 CAD-L: 66.00

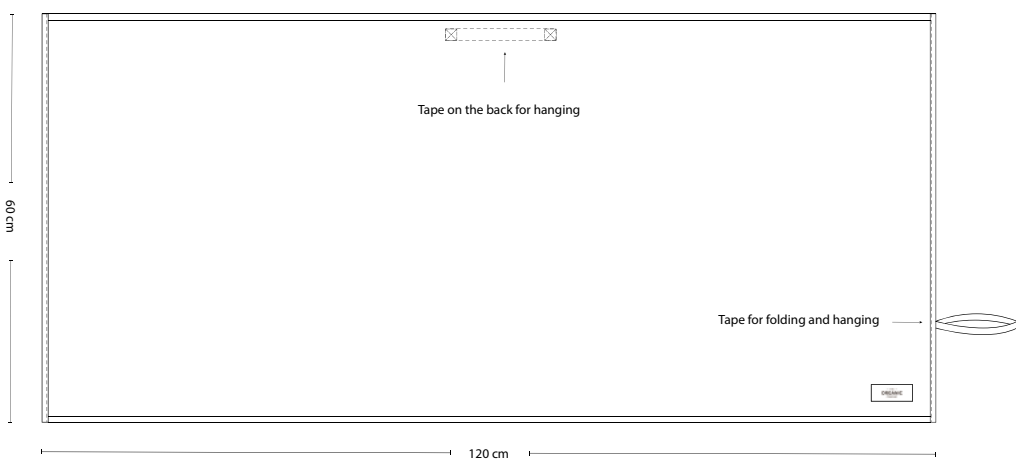

Our towel to go to the gym is so practical for you on the go. A functional strap and roll-function makes it easy to bring to gym or down to the beach for a morning swim. When unfolded you have a medium sized towel with great absorbency.

color: natural white
no: 200



color: dusty lavender
no: 340



color: khaki
no: 215



color: grey blue
no: 510

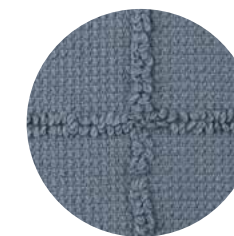

color: stone
no: 202

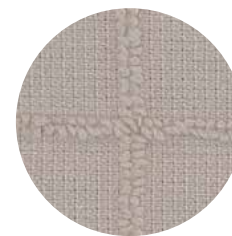

color: clay
no: 225



color: dark grey
no: 110

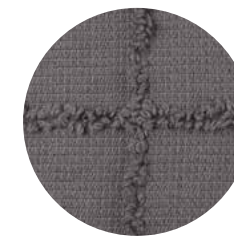

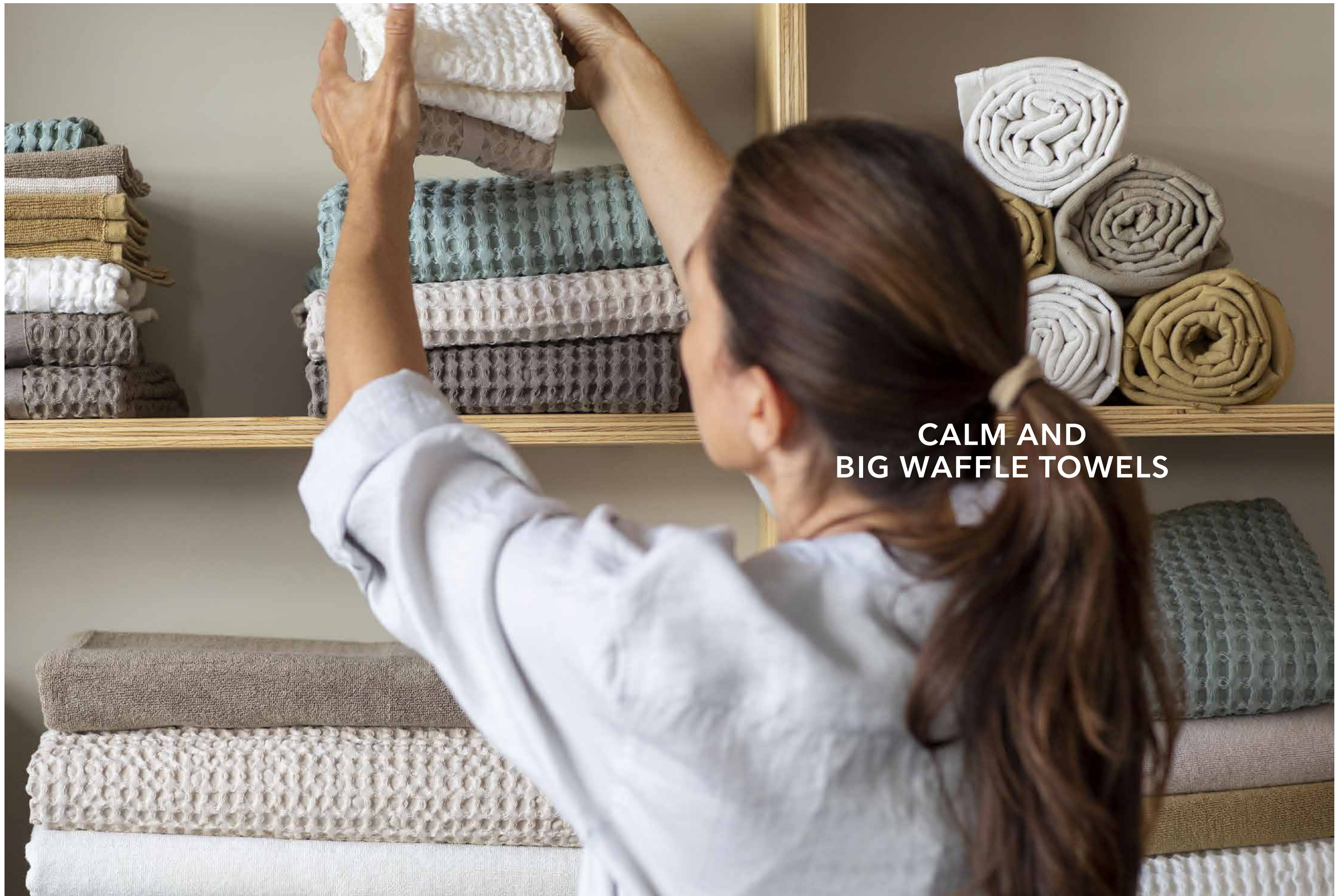

**CALM AND
BIG WAFFLE TOWELS**

CALM HAND TOWEL

HÅNDKLÆDE | HANDTUCH | SERVIETTE DE BAIN

Style no: **TOC 1081**
Size: **40 x 70 cm / 15.7 x 27.5"**
Weaving: **Terry plain**
Material: **100% GOTS certified organic cotton**
MOQ: **4 pieces**

RRP
DKK: **130,-**
EUR: **18.90**
NOK: **190,-**
SEK: **190,-**
USD-L: **24.00**
CAD-L: **32.00**

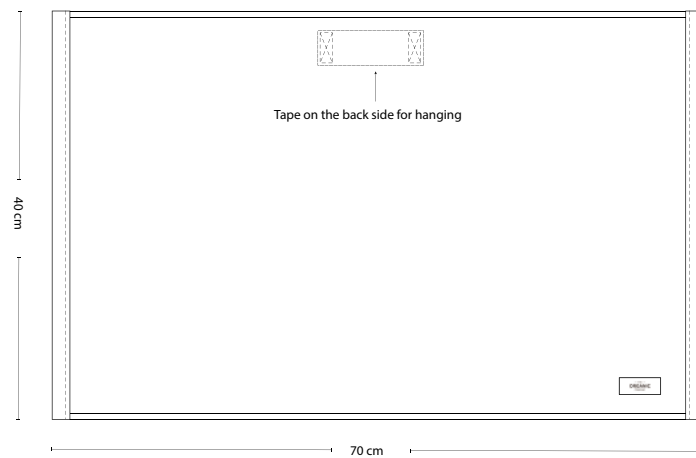

A high-quality hand towel with nice design details and high absorbency. Everyday luxury for you and your guests.



color: **natural white**
no: **200**



color: **khaki**
no: **215**



color: **stone**
no: **202**



color: **clay**
no: **225**



color: **dusty lavender**
no: **340**



color: **dark grey**
no: **110**



color: **grey blue**
no: **510**



CALM WASH CLOTHS

VASKEKLUD | WASCHLAPPEN | SERVIETTE DE INVITÉE

Style no: TOC 1080
Size: Box set of 4 pices, 28 x 28 cm / 11.0 x 11.0"
Weaving: Terry plain
Material: 100% GOTS certified organic cotton
MOQ: 4 boxes

RRP
DKK: 185,-
EUR: 25.90
NOK: 270,-
SEK: 270,-
USD-L: 32.00
CAD-L: 42.00

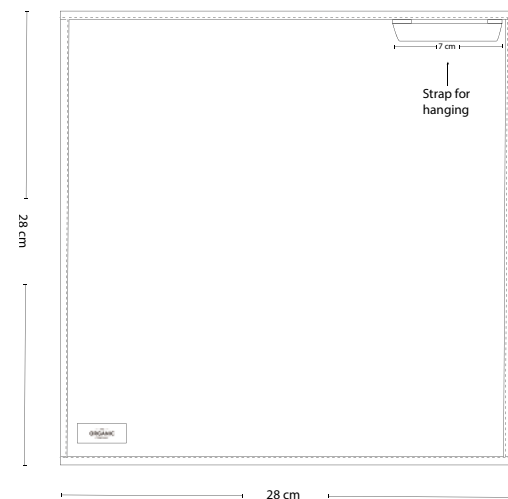

color: natural white
no: 200



color: khaki
no: 215



color: stone
no: 202

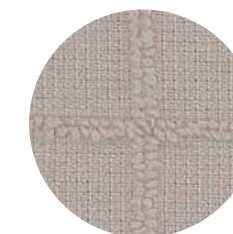

color: clay
no: 225



color: dusty lavender
no: 340



color: dark grey
no: 110

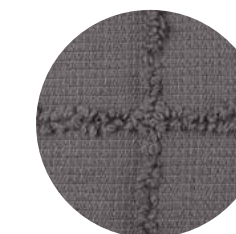

color: grey blue
no: 510

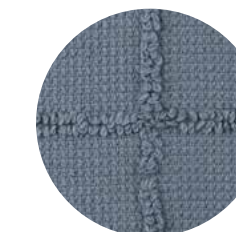

color: earth color mix
no: 901



A high-quality wash cloth with nice design details and high absorbency. Use the wash cloth together with our makeup pads in your daily routines in the bathroom. Comes in packs of 4 pieces.

CALM MAKEUP PADS

RONDELLER | KOSMETIKPADS | TAMPONS DÉMAQUILLANTS

Style no: TOC 1084
Size: Box of 2 square pieces (8 x 8 cm) + 2 rectangular pieces (7x 11 cm) / 3.1 x 3.1 + 2.8 x 4.3"
Weaving: Terry plain
Material: 100% GOTS certified organic cotton
MOQ: 8 boxes

RRP
DKK: 70,-
EUR: 9.90
NOK: 100,-
SEK: 100,-
USD-L: 13.00
CAD-L: 16.50

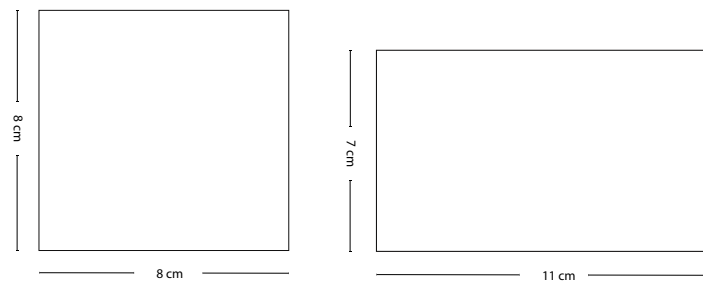

It all came together. To use leftover fabric from our towel production to make soft and reusable pads for facial care and makeup removal. So much better than single use cotton pads. Comes in packs of 4 pieces.

What is your choice?

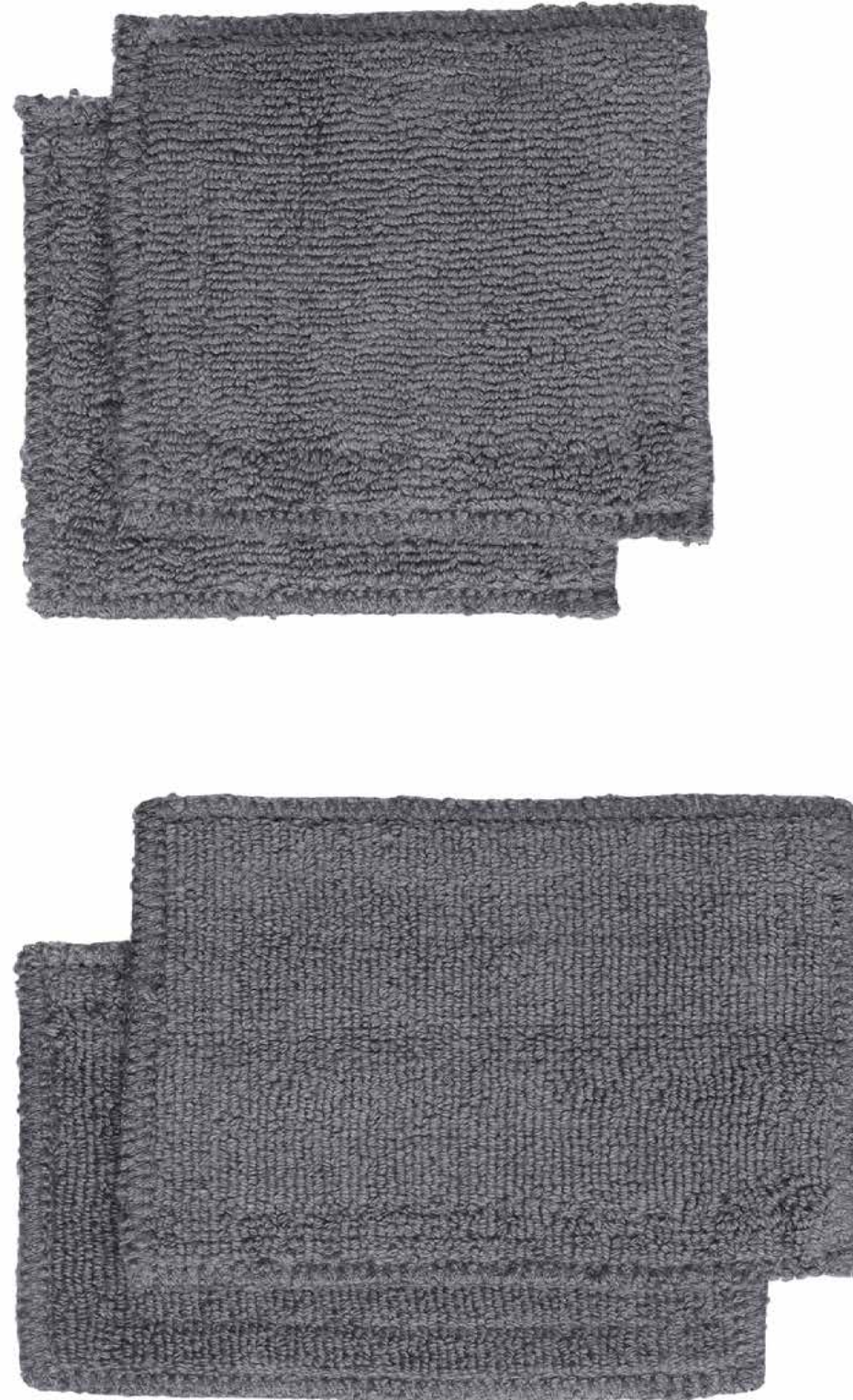

color: natural white
no: 200



color: khaki
no: 215



color: stone
no: 202

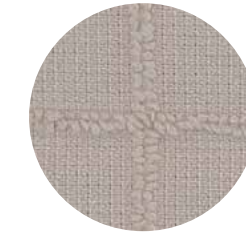

color: clay
no: 225



color: dusty lavender
no: 340



color: dark grey
no: 110



color: grey blue
no: 510

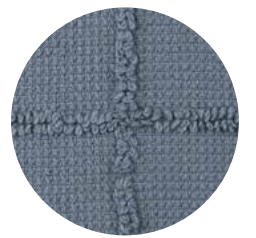

BIG WAFFLE INTRO

BIG WAFFLE is our chunky, comfortable bath series. It is a vivid weave made from regular pure organic cotton. It has a soft hand feel and great absorbency.

The waffle weaving gives the products a warm and cozy feeling, and combined the clean Nordic lines. This is a product in perfect balance.

Mix different colors or styles together with products our CALM or WELLNESS series for the perfectly imperfect look.



BIG WAFFLE TOWEL AND BLANKET

HÅNDKLÆDE | HANDTUCH | SERVIETTE DE BAIN

Style no: TOC 1029
Size: 100 x 150 cm / 39.4 x 59.0"
Weaving: Waffle
Material: 100% GOTS certified organic cotton
MOQ: 4 pieces

RRP
DKK: 555,-
EUR: 77.90
NOK: 785,-
SEK: 785,-
USD-L: 96.00
CAD-L: 125.00

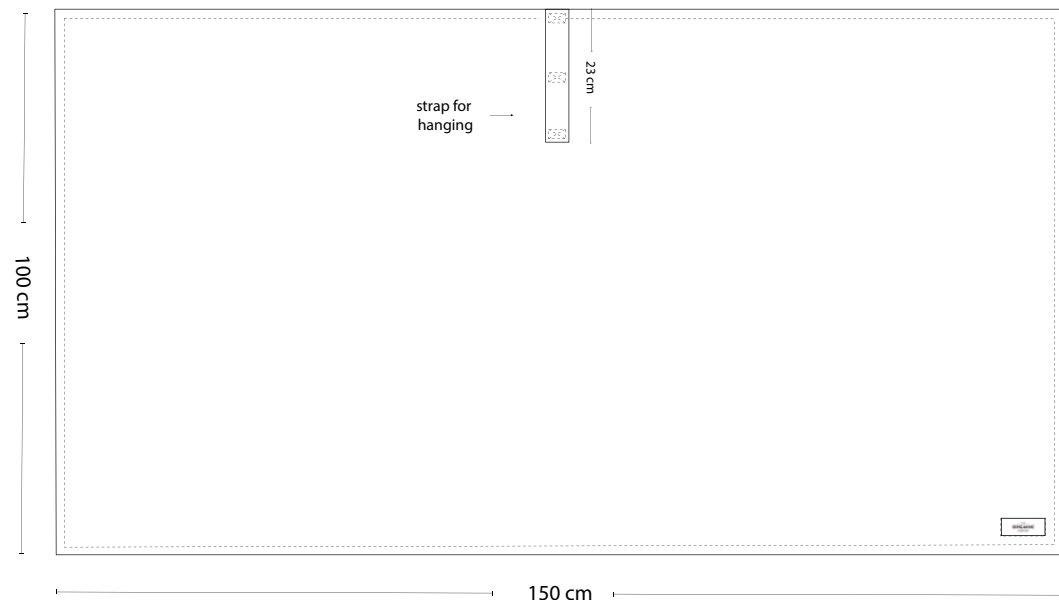

This towel is more than a large and distinct towel with great absorbency. It is also a thick and comfortable blanket for yoga, the beach and on the terrace.

color: natural white
no: 200

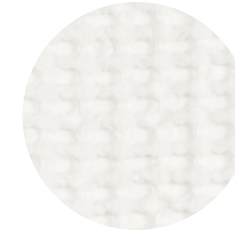

color: stone
no: 202



color: dusty lavender
no: 340 style: TOC1111



LIMITED EDITION

color: dusty mint
no: 410

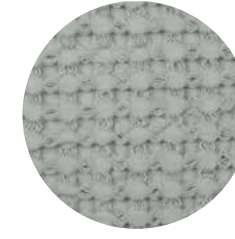

NEW COLOR

color: pale rose
no: 331



color: grey blue
no: 510 style: TOC1111

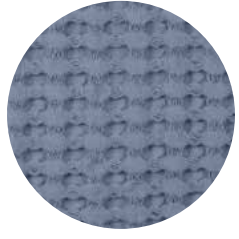

LIMITED EDITION

color: clay
no: 225

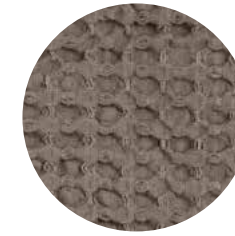

color: dark grey
no: 110

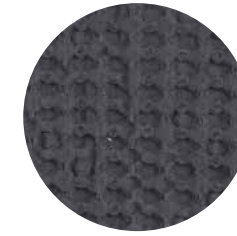

color: dark blue
no: 500 style: TOC1111

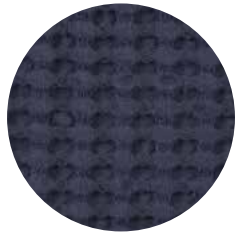

LIMITED EDITION

BIG WAFFLE MEDIUM TOWEL

HÅNDKLÆDE | HANDTUCH | SERVIETTE DE BAIN

Style no: TOC 1025
Size: 50 x 150 cm / 19.7 x 59.0"
Weaving: Waffle
Material: 100% GOTS certified organic cotton
MOQ: 4 pieces

RRP

DKK: 335,-
EUR: 47.90
NOK: 485,-
SEK: 485,-
USD-L: 59.00
CAD-L: 75.00

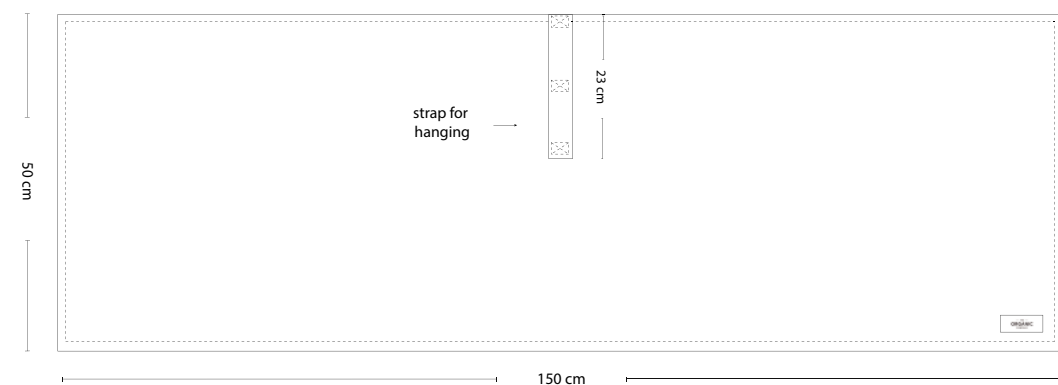

A soft and comfortable towel for hand and body. Towel dimensions make it elegant when it hangs and practical for yoga and travel.

color: natural white
no: 200

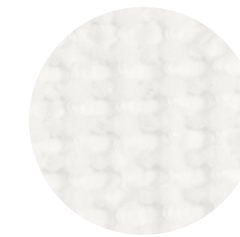

color: stone
no: 202



color: dusty mint
no: 410

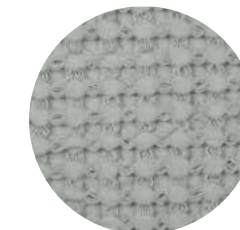

NEW COLOR

color: clay
no: 225

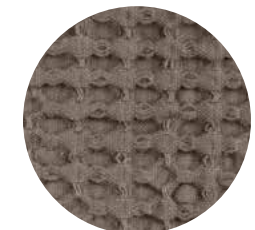

color: pale rose
no: 331

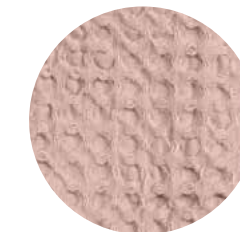

color: dark grey
no: 110

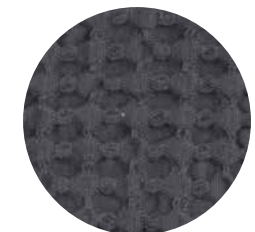

BIG WAFFLE HAND TOWEL

HÅNDKLÆDE | HANDTUCH | SERVIETTE DE BAIN

Style no: TOC 1020
Size: 50 x 75 cm / 19.7 x 29.5"
Weaving: Waffle
Material: 100% GOTS certified organic cotton
MOQ: 4 pieces

RRP

DKK: 165,-
EUR: 22.90
NOK: 250,-
SEK: 250,-
USD-L: 32.00
CAD-L: 38.00

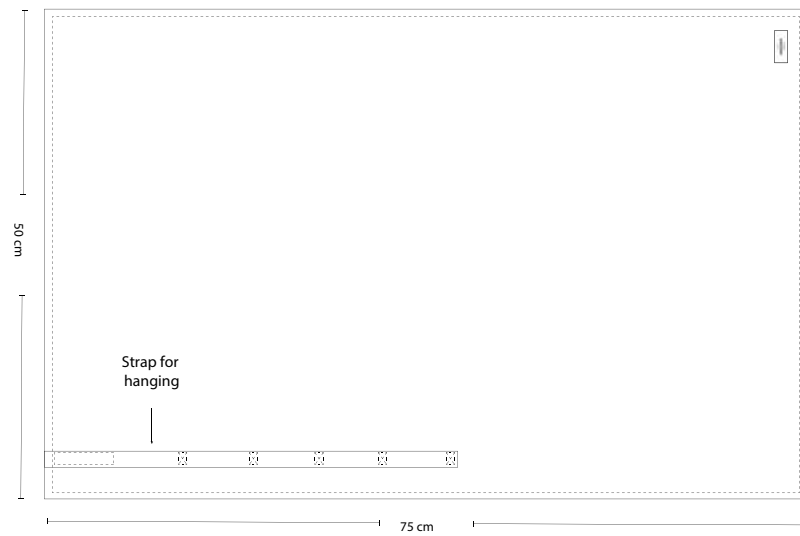

color: natural white
no: 200

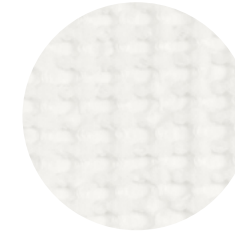

color: stone
no: 202

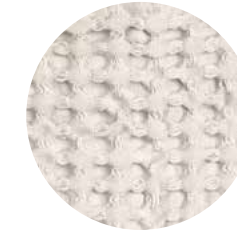

color: dusty lavender
no: 340 style: TOC1112



LIMITED EDITION

color: dusty mint
no: 410

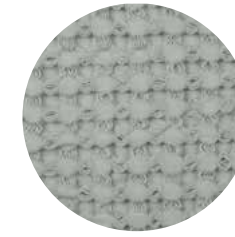

NEW COLOR

color: pale rose
no: 331

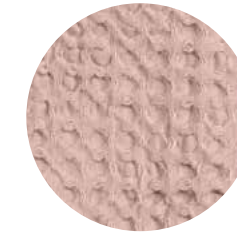

color: grey blue
no: 510 style: TOC1112

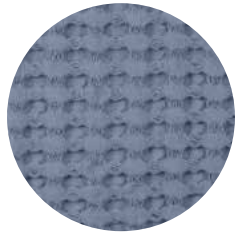

LIMITED EDITION

color: clay
no: 225

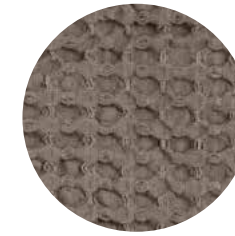

color: dark grey
no: 110

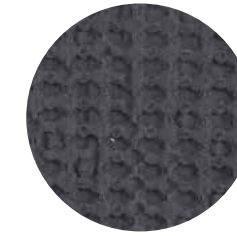

color: dark blue
no: 500 style: TOC1112

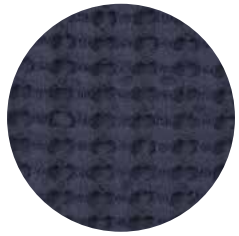

LIMITED EDITION

This piece was developed to make a soft and comfortable guest and hand towel with a designed expression. Great absorbency.

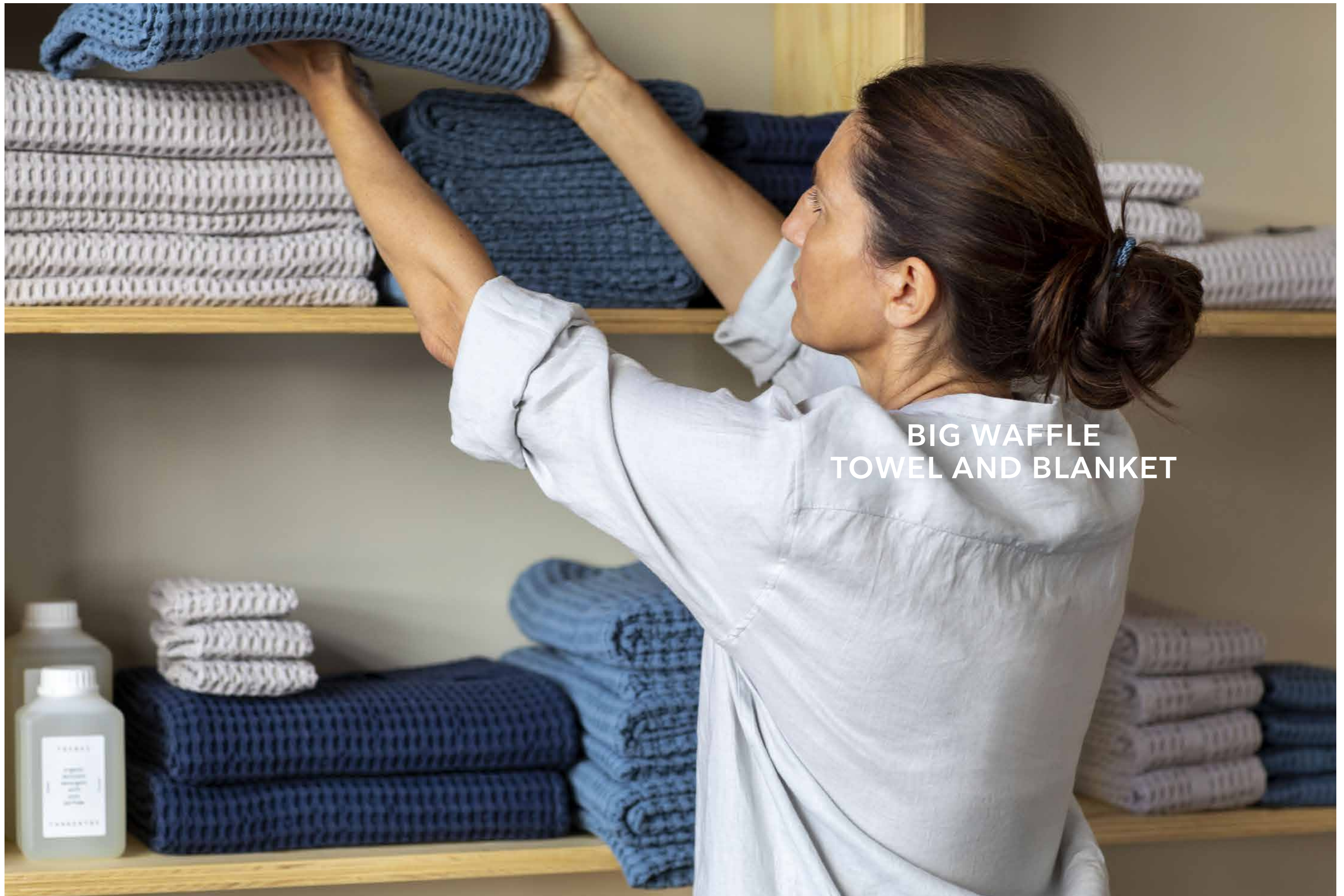

BIG WAFFLE
TOWEL AND BLANKET

BIG WAFFLE WASH CLOTH

VASKEKLUD | WASCHLAPPEN | SERVIETTE DE INVITÉE

Style no: TOC 1027
Size: 25 x 40 cm / 9.8 x 15.7"
Weaving: Waffle
Material: 100% GOTS certified organic cotton
MOQ: 12 pieces

RRP
DKK: 70,-
EUR: 9.90
NOK: 100,-
SEK: 100,-
USD-L: 13.00
CAD-L: 16.50

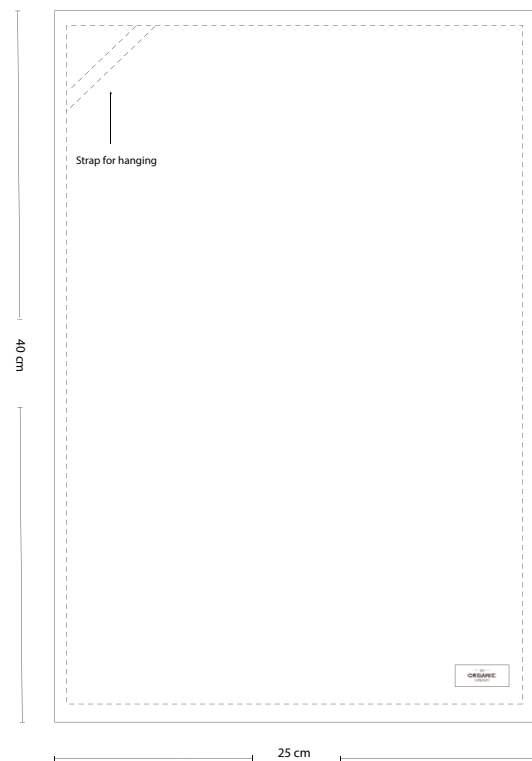

color: natural white
no: 200



color: stone
no: 202

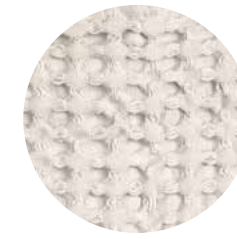

color: dusty lavender
no: 340 style: TOC1113



LIMITED EDITION

color: dusty mint
no: 410

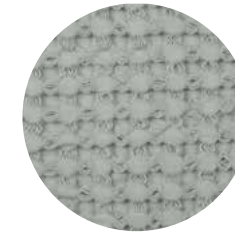

NEW COLOR

color: pale rose
no: 331

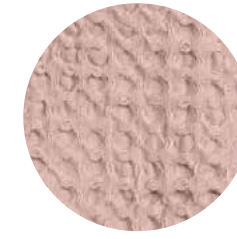

color: grey blue
no: 510 style: TOC1113

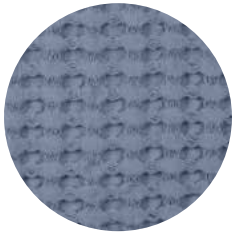

LIMITED EDITION

color: clay
no: 225

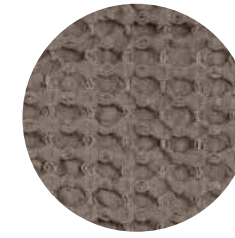

color: dark grey
no: 110

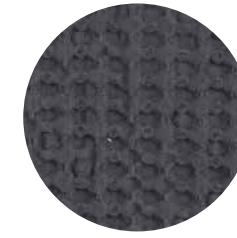

color: dark blue
no: 500 style: TOC1113

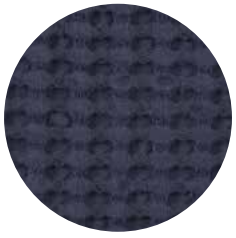

LIMITED EDITION

An absorbent cloth for personal care or a distinct guest towel. With a functional strap. A good-looking piece great in action.

BIG WAFFLE MAKEUP PADS

RONDELLER | KOSMETIKPADS | TAMPONS DÉMAQUILLANTS

Style no: TOC 1017
 Size: Box of 2 square pieces (8 x 8 cm) + 2 oval pieces (7 x 11 cm) / 3.1 x 3.1 + 2.5 x 4.3"
 Weaving: Waffle
 Material: 100% GOTS certified organic cotton
 MOQ: 8 boxes

RRP
 DKK: 70,-
 EUR: 9.90
 NOK: 100,-
 SEK: 100,-
 USD-L: 13.00
 CAD-L: 16.50

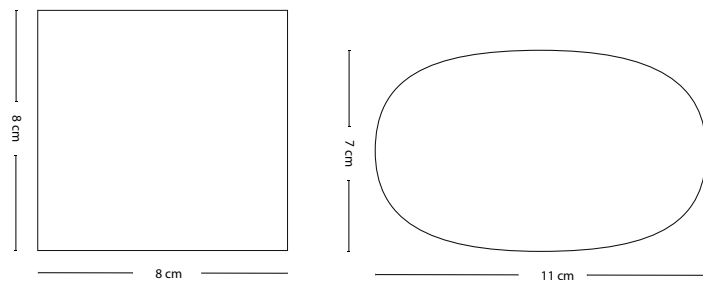

color: natural white
no: 200

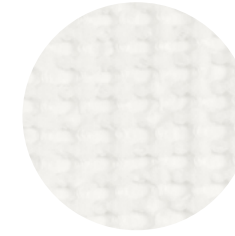

color: stone
no: 202



color: dusty lavender
no: 340 style: TOC1114



LIMITED EDITION

color: dusty mint
no: 410

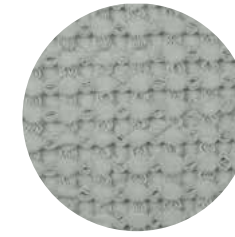

NEW COLOR

color: pale rose
no: 331

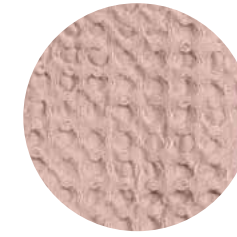

color: grey blue
no: 510 style: TOC1114

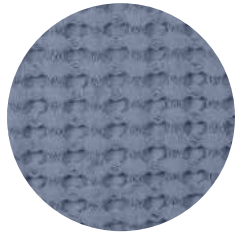

LIMITED EDITION

color: clay
no: 225

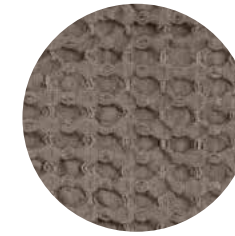

color: dark grey
no: 110

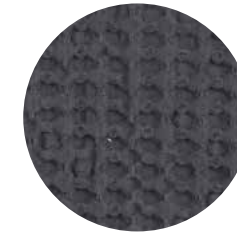

color: dark blue
no: 500 style: TOC1114

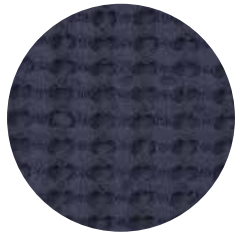

LIMITED EDITION

It all came together. To use leftover fabric from our towel production to make soft and reusable pads for facial care and makeup removal. So much better than single use cotton pads.

What is your choice?



BIG WAFFLE BATH MAT

BIG WAFFLE BATH MAT

BADEMÄTTE | BADEMATTE | TAPIS DE BAIN

Style no: TOC 1026
Size: 80 x 55 cm / 21.7 x 31.5"
Weaving: Waffle
Material: 100% GOTS certified organic cotton
MOQ: 4 pieces

RRP
DKK: 400,-
EUR: 56.90
NOK: 585,-
SEK: 585,-
USD-L: 72.00
CAD-L: 95.00

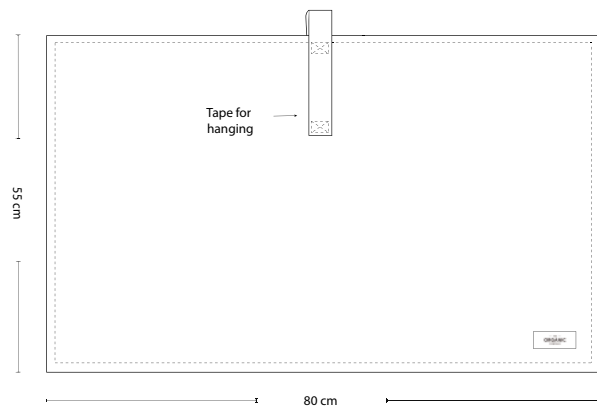

Our bath mat combines the comforting feeling when stepping out of the bath with a modern and relaxed expression. The mat can easily be hung in the strap.



color: natural white
no: 200



color: dusty mint
no: 410

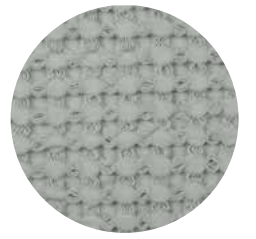

NEW COLOR

color: stone
no: 202



color: clay
no: 225

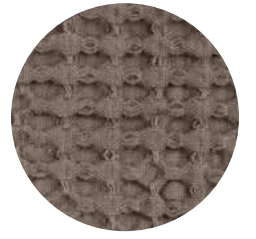

color: pale rose
no: 331

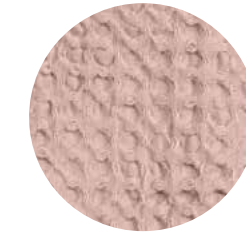

color: dark grey
no: 110



WELLNESS INTRO

Our WELLNESS series combines elegance with exceptional functionality. The piqué weaving in two colors provides a twist to the towel expression and makes it easy to mix with other materials and colors.

The WELLNESS series takes up very little space when folded and dries up fast, and is therefore practical to bring to the beach or for other wellness situations.

Mix different colors together or mix with styles from our CALM or BIG WAFFLE series for the perfectly imperfect look.

The WELLNESS series is enhanced with a wrap functionality - To solve the awkwardness of a towel falling down, when you trust it to stay.



WELLNESS TOWEL

HÅNDKLÆDE | HANDTUCH | SERVIETTE DE BAIN

Style no: TOC 1018
Size: 110 x 165 cm / 43.3 x 64.9"
Weaving: Piqué
Material: 100% GOTS certified organic cotton
MOQ: 4 pieces

RRP
DKK: 475,-
EUR: 66.90
NOK: 685,-
SEK: 685,-
USD-L: 82.00
CAD-L: 110.00

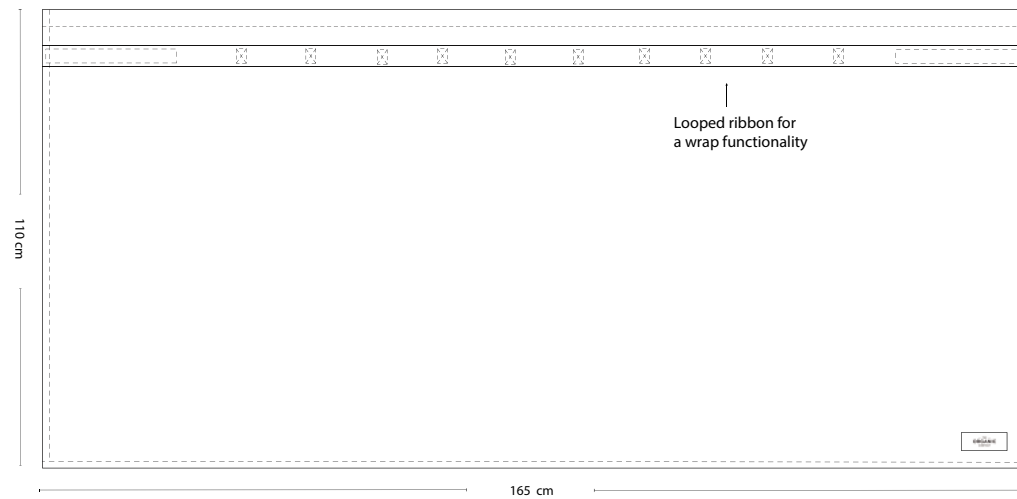

Developed for wellness situations, after the bath and on the beach. This extra-large towel takes up little space when folded. A lightweight towel with great absorbency.



color: stone rose
no: 330



color: morning grey
no: 180



color: grey blue stone
no: 511



color: evening grey
no: 111



TOWEL TO WRAP AROUND YOU

HÅNDKLÆDE | HANDTUCH | SERVIETTE DE BAIN

Style no: TOC 1019
Size: 60 x 155 cm / 23.6 x 61.0"
Weaving: Piqué
Material: 100% GOTS certified organic cotton
MOQ: 4 pieces

RRP
DKK: 325,-
EUR: 45.90
NOK: 475,-
SEK: 475,-
USD-L: 59.00
CAD-L: 75.00

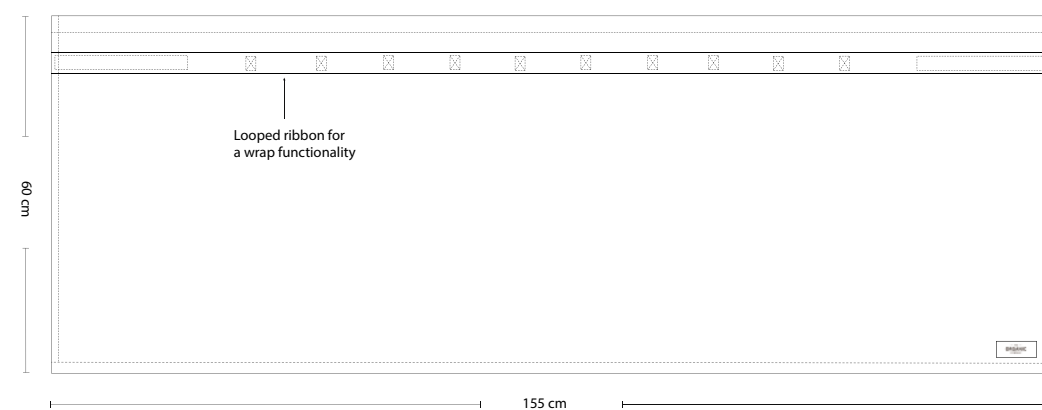

The towel to wrap around you is developed for wellness situations, after the bath and on the beach. This extra-long towel also looks great when hanging in the bathroom. A lightweight towel with great absorbency.



color: stone rose
no: 330

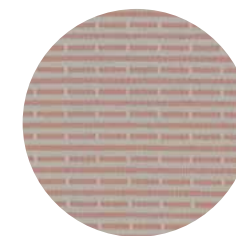

color: morning grey
no: 180



color: grey blue stone
no: 511



color: evening grey
no: 111



HAND HAIR TOWEL

HÅNDKLÆDE | HANDTUCH | SERVIETTE DE BAIN

Style no: TOC 1023
Size: 40 x 120 cm / 15.7 x 47.2"
Weaving: Piqué
Material: 100% GOTS certified organic cotton
MOQ: 4 pieces

RRP
DKK: 210,-
EUR: 29.90
NOK: 295,-
SEK: 295,-
USD-L: 38.00
CAD-L: 48.00

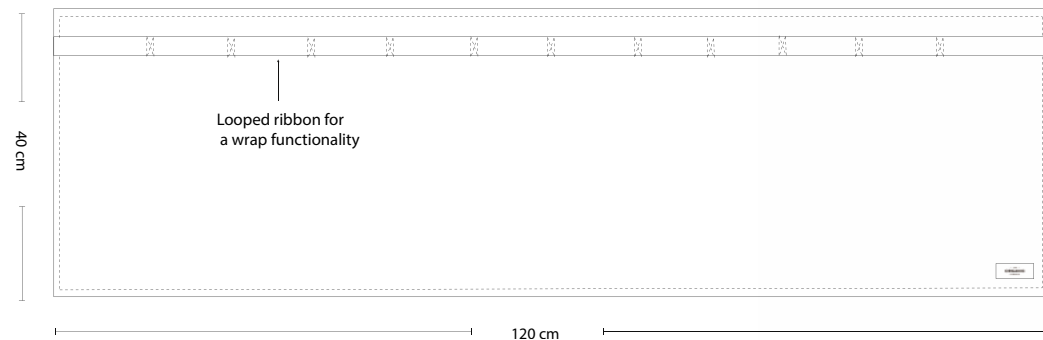

color: stone rose
no: 330



color: morning grey
no: 180



color: grey blue stone
no: 511



color: evening grey
no: 111



The hand hair towel makes the guest towel a nice experience. Enhanced with a hair wrap functionality. A lightweight towel with great absorbency.

WASHING BAG

VASKEPOSE | WÄSCHESACK | SAC À LINGE

SMALL

Style no: TOC 1075
 Size: 17 x 25 cm / 6.7 x 9.8"
 Weaving: Gauze
 Material: 100% GOTS certified organic cotton
 MOQ: 8 pieces

MEDIUM

Style no: TOC 1076
 Size: 25 x 34 cm / 9.8 x 13.4"
 Weaving: Gauze
 Material: 100% GOTS certified organic cotton
 MOQ: 8 pieces

LARGE

Style no: TOC 1077
 Size: 34 x 50 cm / 13.4 x 19.7"
 Weaving: Gauze
 Material: 100% GOTS certified organic cotton
 MOQ: 8 pieces

SET

Style no: TOC 1090
 Size: Washing bag set, 1 small, 1 medium, 1 large
 Weaving: Gauze
 Material: 100% GOTS certified organic cotton
 MOQ: 8 sets

RRP

DKK: 45,-
 EUR: 6.90
 NOK: 65,-
 SEK: 65,-
 USD-L: 9.00
 CAD-L: 12.00

RRP

DKK: 55,-
 EUR: 7.90
 NOK: 80,-
 SEK: 80,-
 USD-L: 10.00
 CAD-L: 13.00

RRP

DKK: 70,-
 EUR: 9.90
 NOK: 100,-
 SEK: 100,-
 USD-L: 13.00
 CAD-L: 16.50

RRP

DKK: 155,-
 EUR: 21.90
 NOK: 235,-
 SEK: 235,-
 USD-L: 26.00
 CAD-L: 36.00

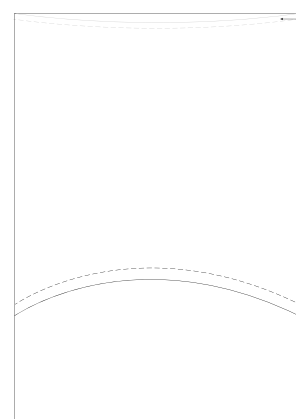
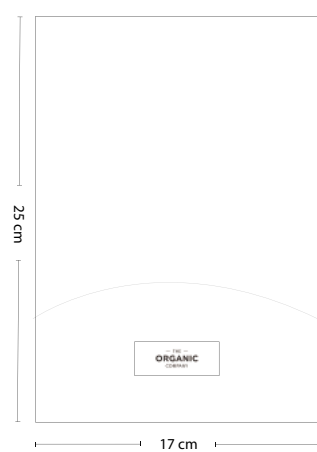

This opening at the top is inside (under flap)

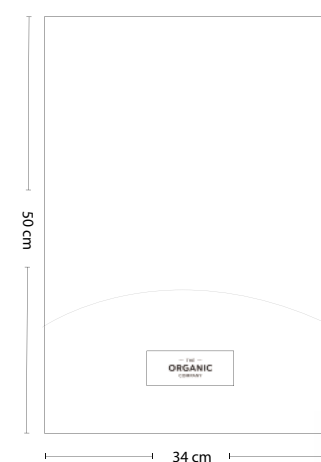
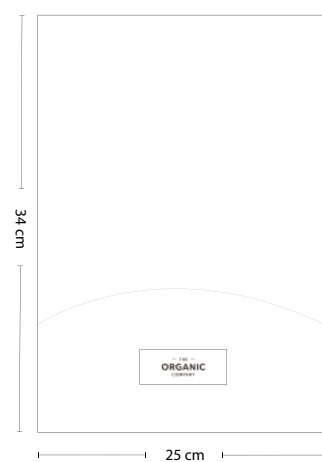

Our washing bag is an alternative to
 1) washing bags made of plastic,
 2) not using a protective bag.
 Helps to make your most delicate
 clothes last longer.

What is your choice?



color: natural white
 no: 200



color: clay
 no: 225

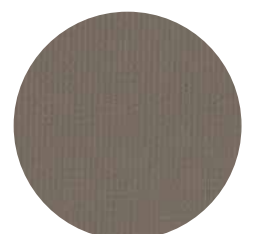

IT MATTERS

100%
ORGANIC
COTTON

BAGS AND
STORAGE



BIG LONG BAG

TASKE | TASCHE | SAC

Style no: TOC 1009
Size: 35 x 45 x 90 cm / 13.8 x 35.4 x 17.7"
Weaving: Heavy canvas
Material: 100% GOTS certified organic cotton
MOQ: 2 pieces

RRP

DKK: 660,-
EUR: 93.90
NOK: 950,-
SEK: 950,-
USD-L: 105.00
CAD-L: 145.00

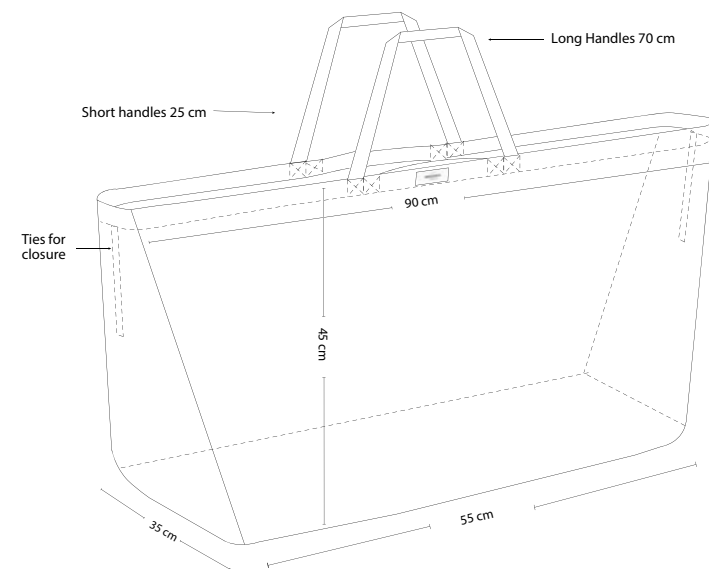

When you carry things for weekend trips, stay-overs and so on. With our big bag, you can be sure of strength and design and of course it is made from organic cotton.



color: pale rose
no: 331



color: stone
no: 202

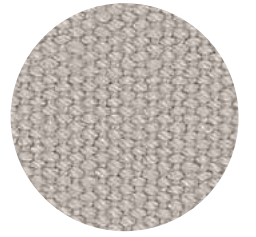

color: clay
no: 225

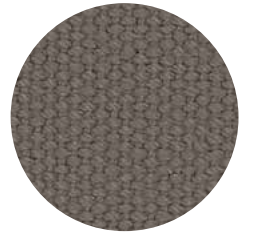

color: dark blue
no: 500



color: black
no: 100



LAUNDRY AND STORAGE BAG

TASKE | TASCHE | SAC

Style no: **TOC 1008**
Size: **70 x 100 cm / 27.6 x 39.4"**
Weaving: **Half panama**
Material: **100% GOTS certified organic cotton**
MOQ: **2 pieces**

RRP
DKK: **300,-**
EUR: **42.90**
NOK: **440,-**
SEK: **440,-**
USD-L: **54.00**
CAD-L: **70.00**

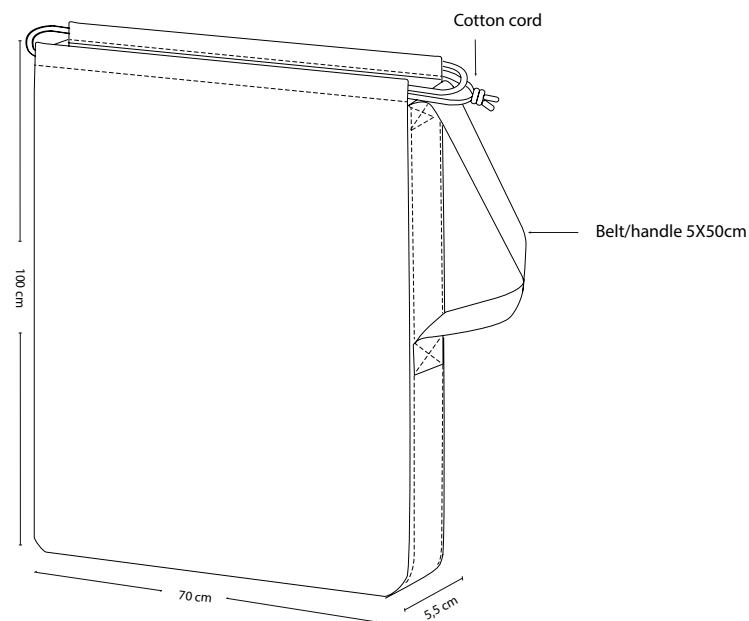

color: **pale rose**
no: **331**



color: **clay**
no: **225**

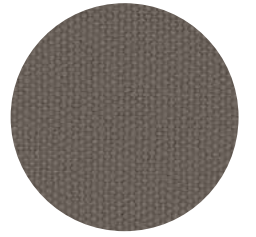

color: **dark grey**
no: **110**



For storage here, there and everywhere. With this big organic beauty bag with drawstrings and a handle, you can simply store textiles, toys and other stuff out in the open.

MY ORGANIC BAG

TASKE | TASCHE | SAC

Style no: TOC 1016
Size: 10 x 34 x 40 cm / 3.9 x 13.4 x 15.7"
Weaving: Heavy canvas
Material: 100% GOTS certified organic cotton
MOQ: 4 pieces

RRP

DKK: 165,-
EUR: 22.90
NOK: 250,-
SEK: 250,-
USD-L: 30.00
CAD-L: 38.00

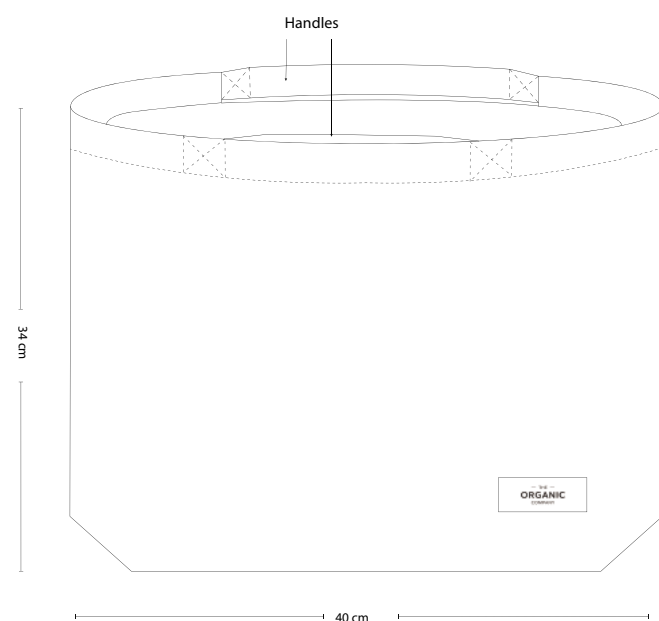

Ready to tote your groceries or on-the-go essentials?
Just reach inside and grab the integrated handles.
Stronger and more durable than plastic.

What is your choice?



color: pale rose
no: 331

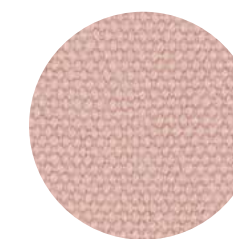

color: dusty mint
no: 410

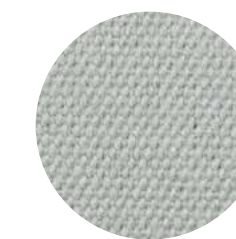

NEW COLOR

color: stone
no: 202

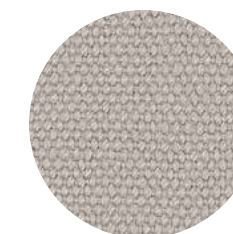

color: grey blue
no: 510

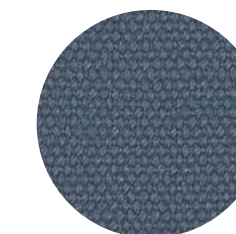

NEW COLOR

color: clay
no: 225

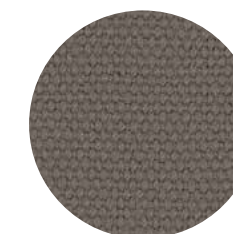

color: dark blue
no: 500



color: khaki
no: 215

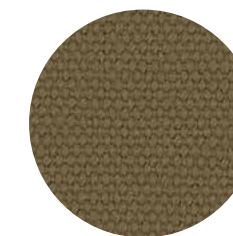

color: black
no: 100

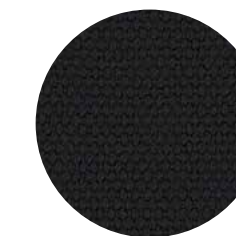

IT MATTERS BAG

TASKE | TASCHE | SAC

Style no: TOC 1128
Size: 50 x 35 x 15 cm / 19.7 x 13.8
Weaving: Plain
Material: 100% GOTS certified organic cotton
MOQ: 8 pieces

RRP

DKK: 130,-
EUR: 18.90
NOK: 190,-
SEK: 190,-
USD-L: 24.00
CAD-L: 32.00

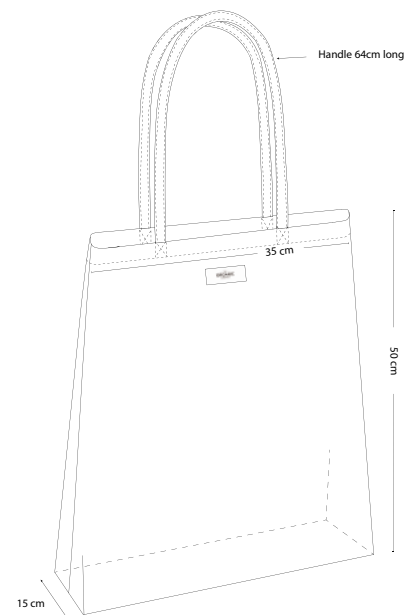

This bag might be your favorite for many years to come. For groceries, the gym and everyday life. If you replace disposable bags with our It Matters Bag you will help to save the planet from hundreds of disposable bags.



color: dusty lavender
no: 340

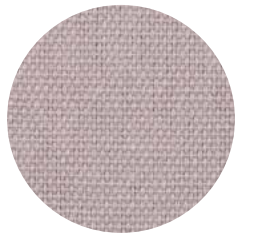

color: clay
no: 225

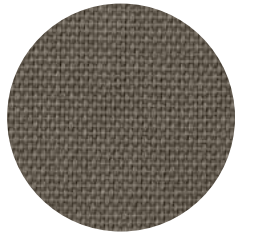

color: dark grey
no: 110

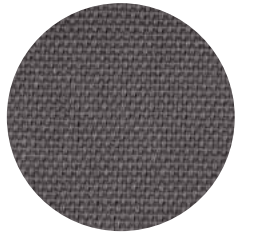

color: dark green
no: 400

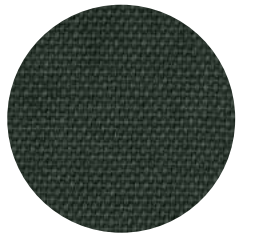

ALL PURPOSE BAG

POSE | BEUTEL | SACHET

SMALL

Style no: **TOC 1013**
 Size: **16 x 22 x 6 cm / 6.3 x 8.7"**
 Weaving: **Gauze**
 Material: **100% GOTS certified organic cotton**
 MOQ: **16 pieces**

RRP

DKK: **40,-**
 EUR: **5.90**
 NOK: **55,-**
 SEK: **55,-**
 USD-L: **8.00**
 CAD-L: **10.00**

MEDIUM

Style no: **TOC 1014**
 Size: **24 x 30 x 8 cm / 9.4 x 11.8"**
 Weaving: **Gauze**
 Material: **100% GOTS certified organic cotton**
 MOQ: **16 pieces**

RRP

DKK: **45,-**
 EUR: **6.90**
 NOK: **65,-**
 SEK: **65,-**
 USD-L: **9.00**
 CAD-L: **12.00**

LARGE

Style no: **TOC 1015**
 Size: **30 x 40 x 12 cm / 11.8 x 15.7"**
 Weaving: **Gauze**
 Material: **100% GOTS certified organic cotton**
 MOQ: **16 pieces**

RRP

DKK: **55,-**
 EUR: **7.90**
 NOK: **80,-**
 SEK: **80,-**
 USD-L: **10.00**
 CAD-L: **13.00**

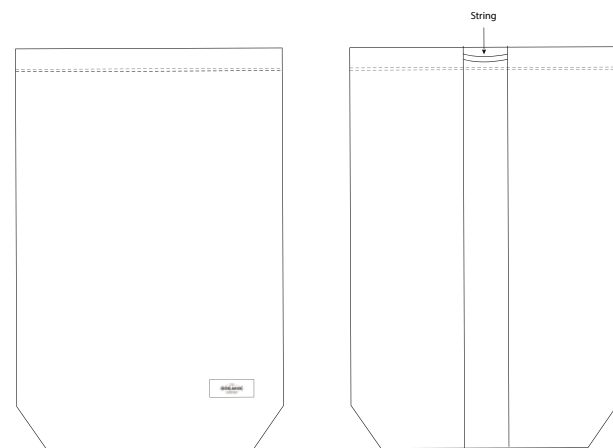

Did you know that we use around 2 million single use plastic bags every minute, on a global scale? The all purpose bag was brought to life to minimize the use of disposable bags. This bag is for hundreds of purposes and can be reused over and over again.

What is your choice?

color: coral
no: 385

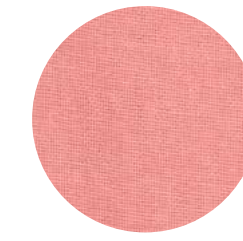

NEW COLOR

color: dusty mint
no: 410

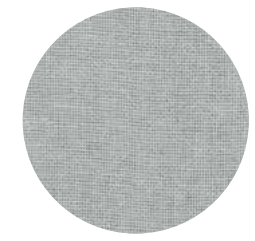

NEW COLOR

color: pale rose
no: 331

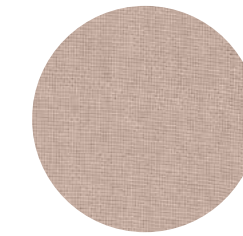

color: grey blue
no: 510

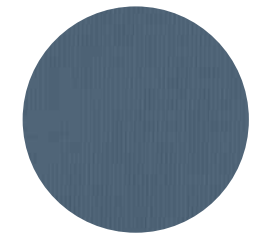

color: clay
no: 225

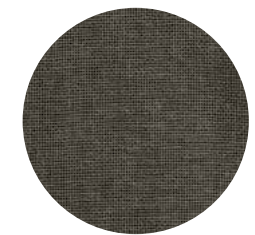

color: dark blue
no: 500

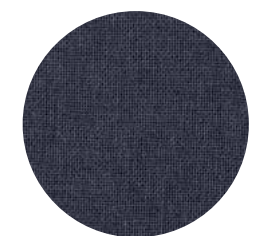

color: black
no: 100

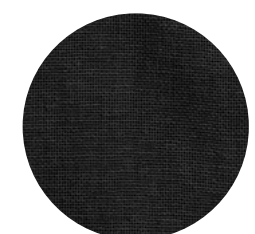

ALL PURPOSE BAG SET

POSE | BEUTEL | SACHET

Style no: TOC 1115
 Size: One size set of 3 pcs. S, M, L
 16 x 22 x 6 cm / 2.3 x 6.3 x 8.7"
 24 x 30 x 8 cm / 3.1 x 9.4 x 11.8"
 30 x 40 x 12 cm / 4.7 x 11.8 x 15.7"
 Weaving: Gauze
 Material: 100% GOTS certified organic cotton
 MOQ: 8 sets

RRP

DKK: 130,-
 EUR: 19.00
 NOK: 190,-
 SEK: 190,-
 USD-L: 24.00
 CAD-L: 32.00

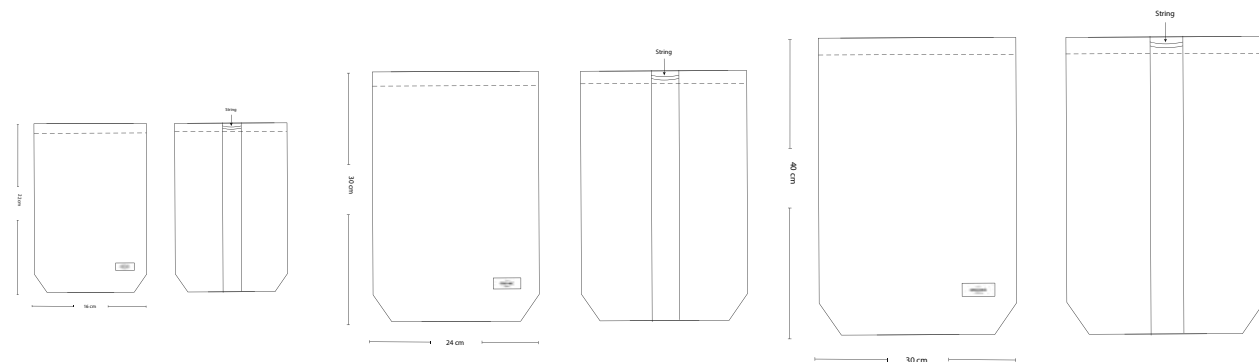

color: coral
no: 385

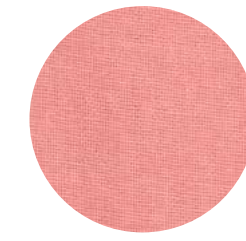

NEW COLOR

color: dusty mint
no: 410

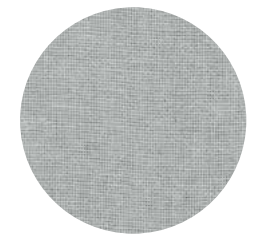

NEW COLOR

color: pale rose
no: 331

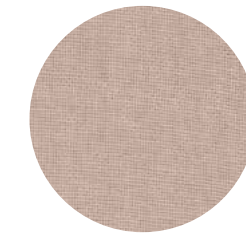

color: grey blue
no: 510

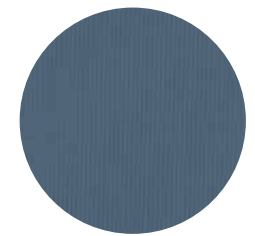

color: clay
no: 225

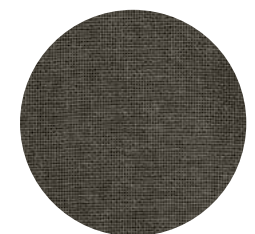

color: dark blue
no: 500

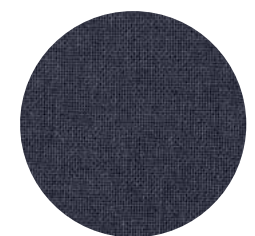

color: black
no: 100

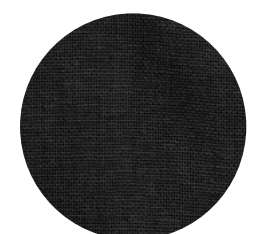

Did you know that we use around 2 million single use plastic bags every minute, on a global scale? The all purpose bag was brought to life to minimize the use of disposable bags. This bag is for hundreds of purposes and can be reused over and over again.

What is your choice?



NET BAG

NET BAG

POSE | BEUTEL | SACHET

SMALL

Style no: TOC 1107
 Size: 22 x 16 x 6 cm / 2.32 x 6.3 x 8.6"
 Weaving: Net fabric (10's x 10's)
 Material: 100% GOTS certified organic cotton
 MOQ: 8 pieces

RRP

DKK: 45,-
 EUR: 6.90
 NOK: 65,-
 SEK: 65,-
 USD-L: 9.00
 CAD-L: 12.00

MEDIUM

Style no: TOC 1108
 Size: 24 x 30 x 8 cm / 3.1 x 11.8 x 9.8"
 Weaving: Net fabric (10's x 10's)
 Material: 100% GOTS certified organic cotton
 MOQ: 8 pieces

RRP

DKK: 55,-
 EUR: 7.90
 NOK: 80,-
 SEK: 80,-
 USD-L: 10.00
 CAD-L: 13.00

LARGE

Style no: TOC 1109
 Size: 30 x 40 x 12 cm / 4.7 x 11.8 x 15.7"
 Weaving: Net fabric (10's x 10's)
 Material: 100% GOTS certified organic cotton
 MOQ: 8 pieces

RRP

DKK: 70,-
 EUR: 9.90
 NOK: 100,-
 SEK: 100,-
 USD-L: 13.00
 CAD-L: 16.50

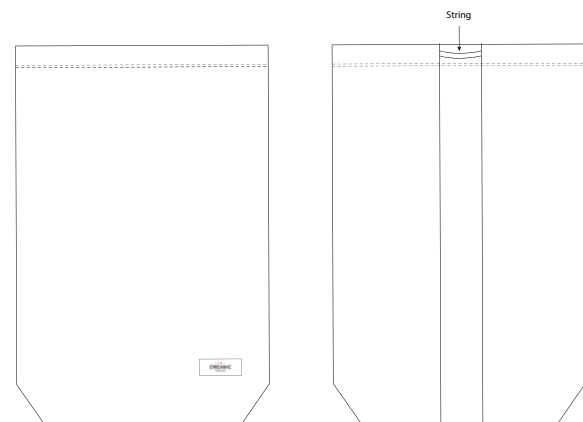

Did you know that we use around 2 million single use, plastic bags every minute, on a global scale?
 The Net bag is a reusable bag that replaces disposable bags.
 It is safe as food storage or to carry your accessories around.

What is your choice?



color: stone
 no: 202

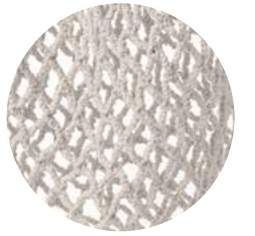

color: dusty lavender
 no: 340

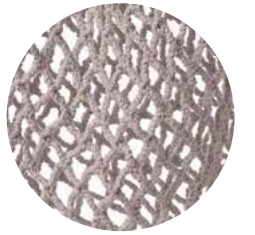

color: clay
 no: 225

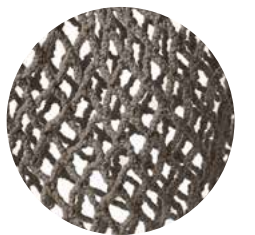

color: dark green
 no: 400

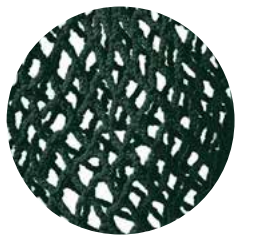



GIFT WRAPPING SET

GIFT WRAPPING SET

GAVEINDPAKNING / VERPACKUNG / EMBALLAGE

Style no: TOC 1092

Size: 1 piece 45 x 45 cm, 1 piece 60 x 60 cm, 1 piece 75 x 75 cm / 17.7 x 17.7 / 23.6 x 23.6 / 29.5 x 29.5"

Weaving: Plain

Material: 100% GOTS certified organic cotton

MOQ: 4 sets

RRP

DKK: 185,-

EUR: 25.90

NOK: 270,-

SEK: 270,-

USD-L: 32.00

CAD-L: 42.00

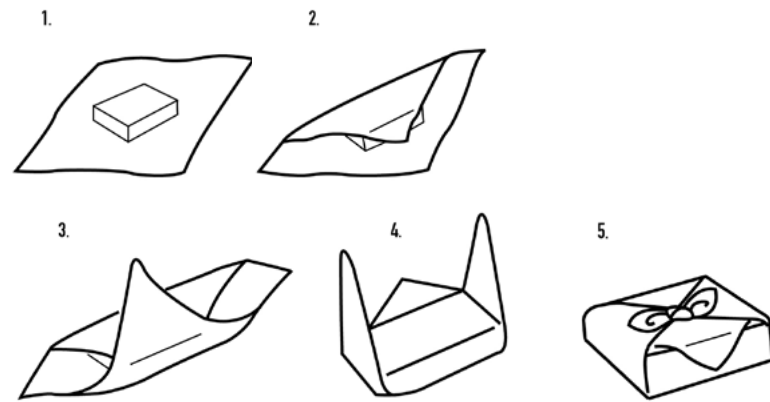

Wrapping paper is often used only once and creates massive waste. Therefore, our Nordic version of the Japanese 'Furoshiki' makes so much sense.

Can be used and reused as many times as you want while you enjoy the creative process of wrapping many beautiful presents.

What is your choice?

color: floral set
no: 982

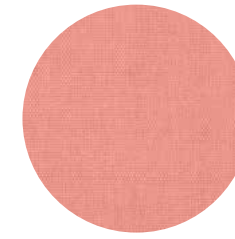

coral / 45 x 45 cm

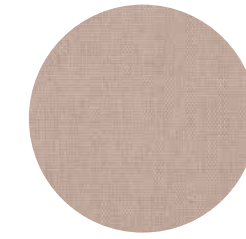

pale rose / 60 x 60 cm

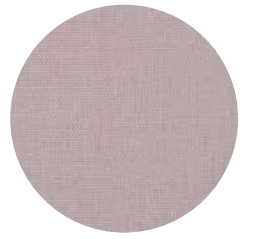

dusty lavender / 75 x 75 cm

color: ocean set
no: 983

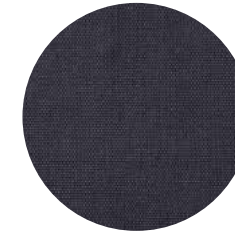

dark blue / 45 x 45 cm

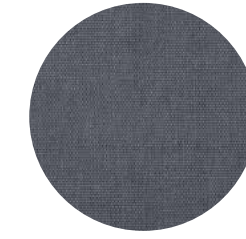

grey blue / 60 x 60 cm

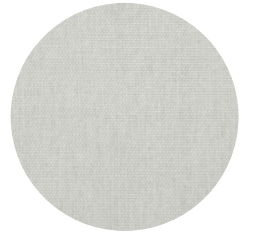

sky / 75 x 75 cm

color: earth set
no: 981

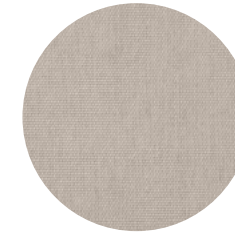

stone / 45 x 45 cm

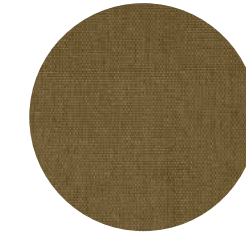

khaki / 60 x 60 cm

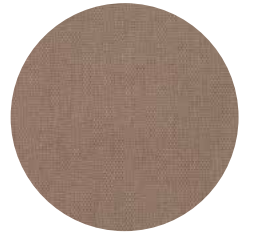

clay / 75 x 75 cm





RELAX AND
MEDITATION

6-LAYER SOFT BLANKET

TÆPPE | DECKE | COUVERTURE

Style no: TOC 1063
Size: 140 x 200 cm / 55.1 x 78.7"
Weaving: Gauze
Material: 100% GOTS certified organic cotton
MOQ: 2 pieces

RRP

DKK: 1195,-
EUR: 169.90
NOK: 1685,-
SEK: 1685,-
USD-L: 220.00
CAD-L: 270.00

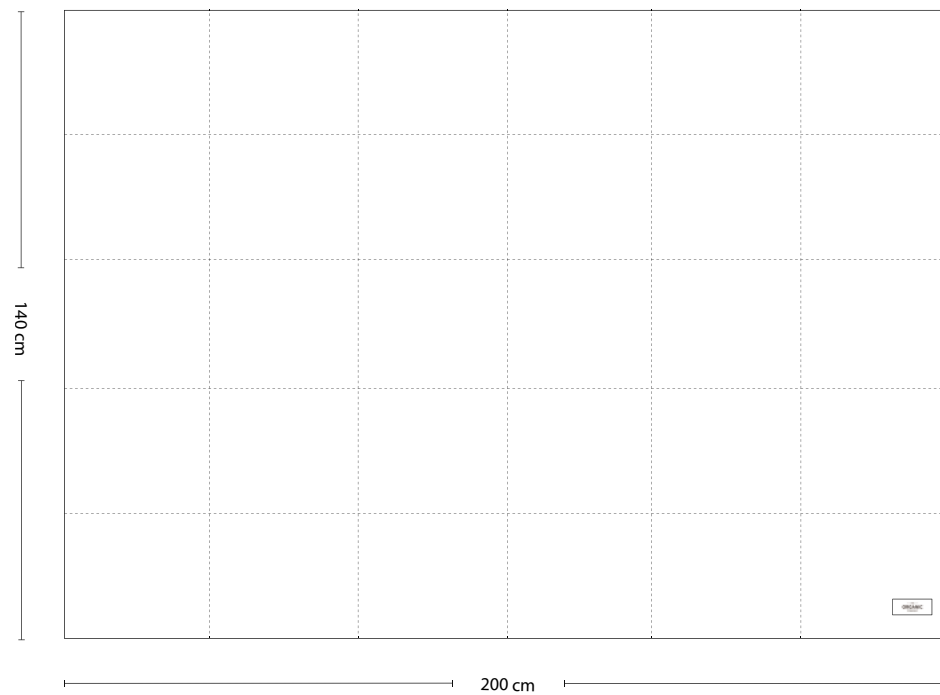

Delicate throw for the many times you are needing that extra cosy layer. At home or when out, taking care of yourself. Pure and soft on your skin with no less than 6 organic cotton lightweight layers. Keeping you warm for your meditative and relaxing moment.

color: clay
no: 225

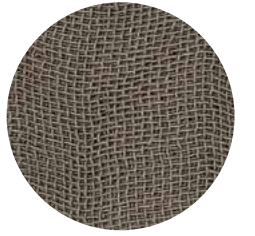

color: dark grey
no: 110

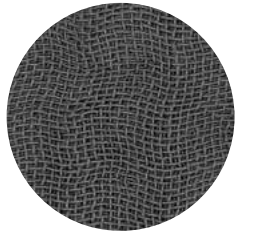

MEDITATION BLOCK

PUDE | KISSEN | COUSSIN

Style no: **TOC 1123**
Size: **11 x 20 x 9 cm / 3.5 x 4.3 x 7.8"**
Weaving: **Heavy canvas**
Material: **100% GOTS certified organic cotton**
MOQ: **4 pieces**

Style no: **TOC 1124 (empty)**
Size: **11 x 20 x 9 cm / 3.5 x 4.3 x 7.8"**
Weaving: **Heavy canvas**
Material: **100% GOTS certified organic cotton**
MOQ: **4 pieces**

RRP
DKK: **185,-**
EUR: **25.90**
NOK: **270,-**
SEK: **270,-**
USD-L: **32.00**
CAD-L: **42.00**

RRP
DKK: **105,-**
EUR: **14.90**
NOK: **155,-**
SEK: **155,-**
USD-L: **22.00**
CAD-L: **28.00**

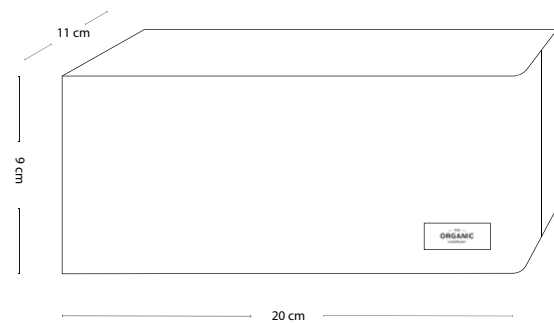

color: **clay**
no: **225**

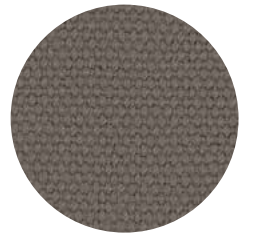

color: **dark blue**
no: **500**

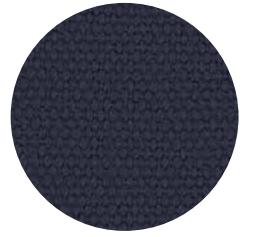

color: **dark grey**
no: **110**



"For a better posture when meditating and doing seated yoga poses. Filled with pure organic cotton to support an organic lifestyle in balance."



**MEDITATION CUSHION FLAT
AND MEDITATION BLOCK**

MEDITATION CUSHION FLAT

PUDE | KISSEN | COUSSIN

Style no: TOC 1125
Size: 20 x 30 x 5 cm / 7.8 x 11.8 x 1.9"
Weaving: Half panama
Material: 100% GOTS certified organic cotton
MOQ: 4 pieces

RRP
DKK: 185,-
EUR: 25.90
NOK: 270,-
SEK: 270,-
USD-L: 32.00
CAD-L: 42.00

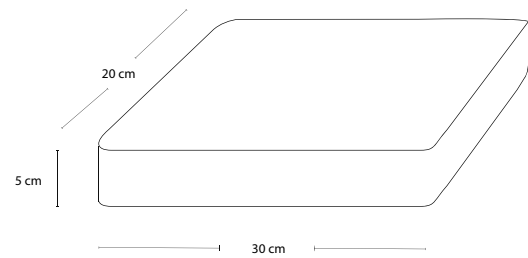

color: clay
no: 225



color: dark blue
no: 500



color: dark grey
no: 110



”For a better posture when meditating and doing seated yoga poses. Filled with pure organic cotton to support an organic lifestyle in balance.”

MEDITATION MATTRESS – TO GO

MADRAS | MATTE | MATELAS

Style no: TOC 1064
Size: 70 x 200 cm / 1.2 x 27.5 x 78.7”
Weaving: Herringbone, organic cotton wadding
Material: 100% GOTS certified organic cotton
MOQ: 2 pieces

RRP

DKK: 1345,-
EUR: 190.90
NOK: 1975,-
SEK: 1975,-
USD-L: 230.00
CAD-L: 310.00



color: dark grey
no: 110

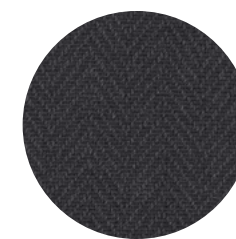

color: dark blue
no: 500

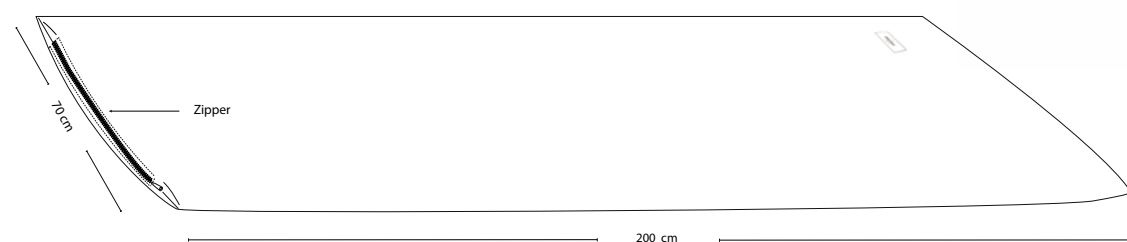
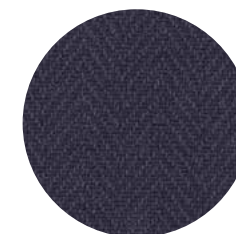

Meditation is for many the key to inner peace. Our mattress is developed to make it easier for you to reach this state of mind; it's soft, comfortable and made from pure organic cotton, also on the inside. Easy to carry with the accompanying belt. Washable cover and easy to bring along, to go.

MEDITATION MATTRESS

MADRAS | MATTE | MATELAS

color: clay
no: 225

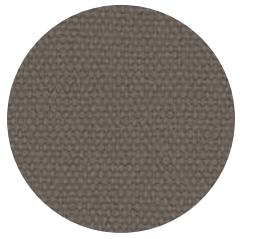

Style no: TOC 1126
Size: 70 x 200 cm / 27.5 x 78.7 x 1,2"
Weaving: Canvas, organic cotton wadding
Material: 100% GOTS certified organic cotton
MOQ: 2 pieces

RRP

DKK: 1345,-
EUR: 190.90
NOK: 1975,-
SEK: 1975,-
USD-L: 230.00
CAD-L: 310.00

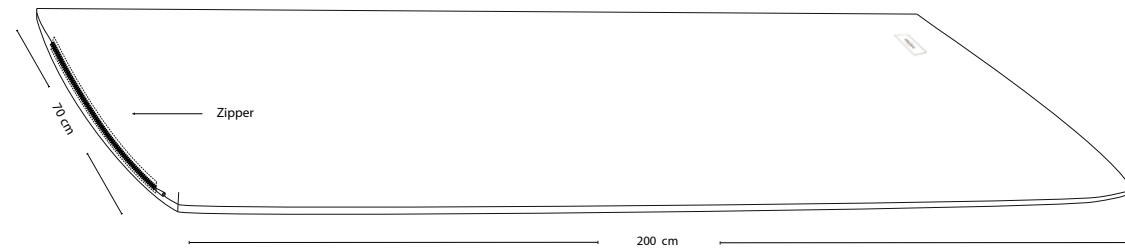

Meditation is for many the key to inner peace. Our mattress is developed to make it easier for you to reach this state of mind; it's soft, comfortable and made from pure organic cotton, also on the inside. Washable cover.

Knowing that we live in the world in a way
that considers the life of future generations
makes our conscience better and provides
lots of positive energy.

Thank you for making a difference
by going organic.

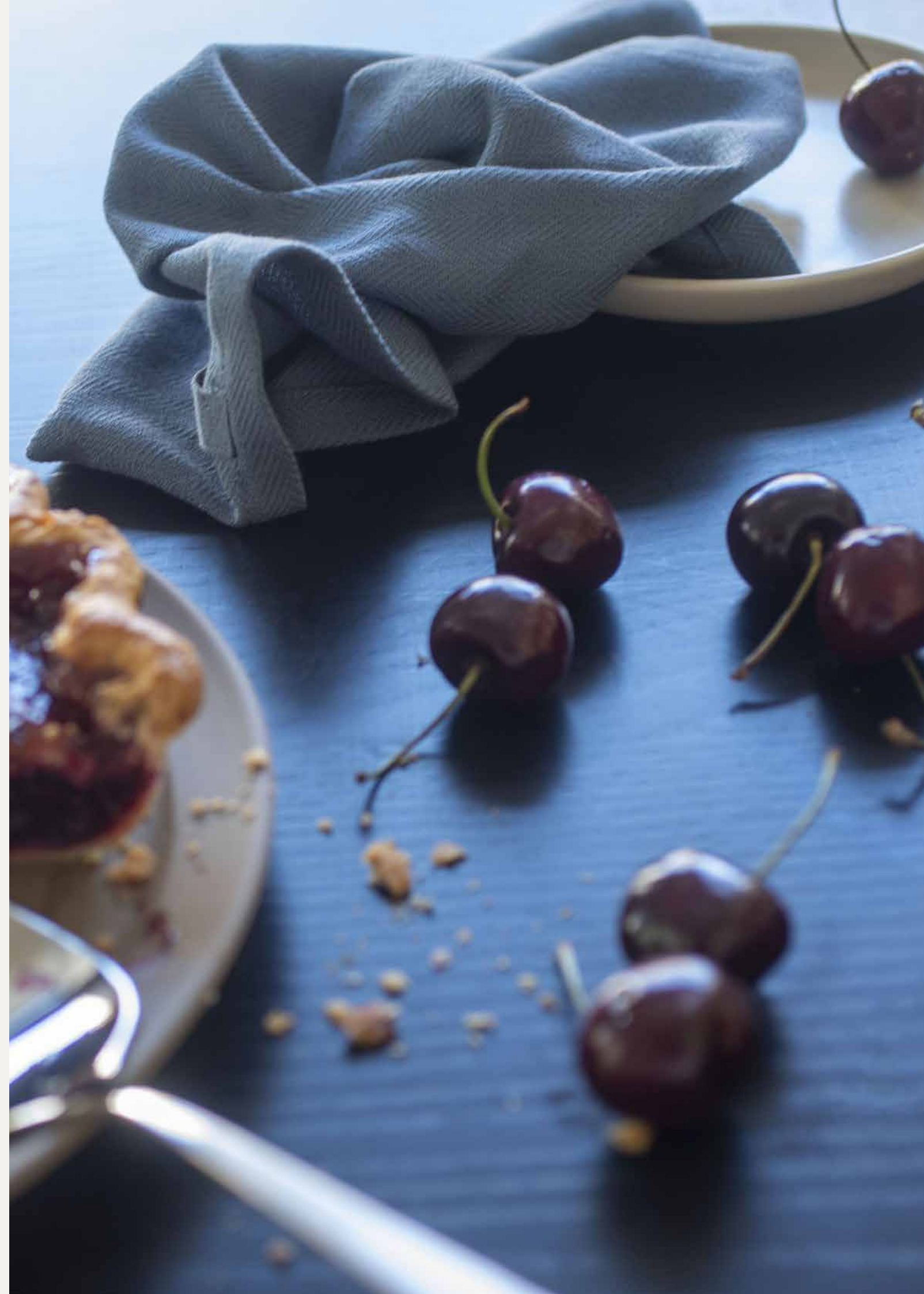

AGENTS AND DISTRIBUTORS

DENMARK

Schønemann Agentur
per@schonemann.eu
Tel: +45 31324332
SoMe: @schonemannagentur
www.schonemann.eu

NORWAY

Chakra Agenturer AS
charlotte@chakra-agenturer.no
Tel: +47 90 60 82 95
SoMe: @chakraagentur
www.chakra-agenturer.no

SWEDEN

EMSA showroom AB
erika@emsashowroom.se
Tel: +46 709 11 33 68
SoMe: @emashowroom
www.emsashowroom.se

FINLAND

HR-Living
info@hrliving.fi
Tel: +35 8407005882
SoMe: @hrliving
www.hrliving.fi

ICELAND

Heggis
heggis@ferli.is
Tel: +354 898 0598
www.heggis.is

UK AND IRELAND

Hyggen
pianna@hyggen.co.uk
Tel: +44 (0) 7990 800542
SoMe: @hyggen_pianna
www.hyggen.co.uk

NORTHERN ENGLAND

urbanoutline@binternet.co.uk
Tel: +44 (0) 7800 869977

SOUTH EAST AND SOUTH WEST ENGLAND

lou@compendiumsales.co.uk
Tel: +44 (0) 7931 588335
SoMe: @compendium_sales

SCOTLAND

agency-charlotte@spektakular.co.uk
Tel: +44 (0) 0771 70 21818

DACH

House of Nordic Living
hello@houseofnordicliving.com
Tel: +45 40 49 28 29
SoMe: @houseofnordicliving_
www.houseofnordicliving.com

WESTERN GERMANY AND BERLIN

P4 Marketing
dominique.vogel@p4marketing.de
Tel: +49 176 - 5688 5485
SoMe: @P4marketing
www.p4marketing.de/brands

BELGIUM AND LUXEMBURG

KOOS
info@kooslifestyle.be
Tel: +32 (0)494 88 73 59
www.kooslifestyle.be

FRANCE

Isabelle Wach
iwach.pro@gmail.com
Tel: +33 6 16 85 51 81

SPAIN & PORTUGAL

Bazaar-Design
anabordaberry@bazaar-design.com
Tel: +59 897 341507
SoMe: @bazaar_design.es
www.bazaar-design.com

USA

Aesthetic Movement
order@aestheticmovement.com
Tel: +1 781-797-5750
SoMe: @aestheticmovement
www.aestheticmovement.com

JAPAN

Marc's International Co. Ltd.
info@marcs.co.jp
Tel: +81 368614511
SoMe: @marcsinternational
www.marcs.co.jp

WESTERN CANADA

Warner McDaniel Agency
warnermcdaniel@gmail.com
Tel +1 604-288-0050
SoMe: @warnermcdanielagency
www.warnermcdanielagency.com

EASTERN CANADA

HeadCorr Inc.
carl@headcorr.ca
Tel: +1 416-893-6780
www.headcorr.ca

AD / LAY-OUT | JE:SU Graphic Design

PHOTO | Anne Mie Drewes | Line Thit Klein | Alex Buck | Storm Ravn | Unsplash

STYLING | JE:SU | Hanne Vind | Tine Darling | The Organic Company

THE ORGANIC COMPANY APS

Rådmandsgade 10A
2200 Copenhagen N
Denmark
Tel: +45 2880 1111

info@theorganiccompany.dk
www.theorganiccompany.dk
www.theorganiccompanydk.com

SoMe: @theorganiccompany
Facebook: The.Organic.Company

THE ORGANIC COMPANY USA INC

Rikke Bitsch-Norhave
Tel: +1 781-228-9167
rikke@theorganiccompany.dk
SoMe: @rikke_theorganiccompany
www.theorganiccompanydk.com

To download the product images
used in the catalogue:
www.theorganiccompany.kontainer.com

Copyright © 2021 | All rights reserved.



IT MATTERS

THE ORGANIC COMPANY

Rådmandsgade 10A
2200 Copenhagen N
Denmark

info@theorganiccompany.dk
Tel: +45 2880 1111

www.theorganiccompany.dk
www.theorganiccompanydk.com

Instagram: @theorganiccompany
Facebook: The.Organic.Company